




OmegaPAT XA
MI 3360
Instruction manual
Ver. 1.2.2, Code no. 20 752 658

Distributor:

Manufacturer:

Metrel d.d.
Ljubljanska cesta 77
SI-1354 Horjul
E-mail: metrel@metrel.si
<http://www.metrel.si>

 Mark on your equipment certifies that it meets European Union requirements for EMC, LVD, ROHS regulations

© 2017 Metrel

The trade names Metrel, Smartec, Eurotest, Autosequence are trademarks registered or pending in Europe and other countries
No part of this publication may be reproduced or utilized in any form or by any means without permission in writing from METREL.

TABLE OF CONTENTS

1	General description	7
1.1	Warnings and notes.....	7
1.1.1	<i>Safety warnings</i>	7
1.1.2	<i>Warnings related to safety of measurement functions</i>	8
1.1.2.1	Flash HV	8
1.1.2.2	Differential leak., Ipe leak., Touch leak., Ileak (W-PE), Primary leak., Power, Leak's & Power, Equipment leak., Applied part leak.	8
1.1.2.3	Insulation resistance.....	8
1.1.3	<i>Markings on the instrument</i>	8
1.2	Power management	9
1.2.1	<i>230 V / 110 V operation</i>	9
1.2.2	<i>Battery and charging, auto power off</i>	9
1.2.3	<i>Power Off, Restart</i>	9
1.3	Standards applied.....	9
2	Instrument set and accessories.....	11
2.1	Standard set of the instrument	11
2.2	Optional accessories	11
3	Instrument description.....	12
3.1	Front panel.....	12
4	Instrument operation.....	14
4.1	General meaning of keys.....	14
4.2	General meaning of touch gestures	14
4.3	Virtual keyboard.....	15
4.4	Safety checks	15
4.5	Symbols and messages	16
4.6	Instrument main menu.....	20
4.7	General settings.....	21
4.7.1	<i>Language</i>	22
4.7.2	<i>Date and time</i>	22
4.7.3	<i>Profiles</i>	22
4.7.4	<i>Workspace Manager</i>	22
4.7.5	<i>Auto Sequence® groups</i>	22
4.7.6	<i>Settings</i>	23
4.7.7	<i>Initial Settings</i>	24
4.7.8	<i>About</i>	24
4.7.9	<i>User Accounts</i>	25
4.7.9.1	Signing in.....	25
4.7.9.2	Changing user password, signing out.....	26
4.7.9.3	Managing accounts	27
4.8	Devices	29
4.9	Instrument profiles	30
4.10	Workspace Manager	31
4.10.1	<i>Workspaces and Exports</i>	31
4.10.2	<i>Workspace Manager main menu</i>	31
4.10.2.1	Operations with Workspaces	32
4.10.2.2	Operations with Exports	33
4.10.2.3	Adding a new Workspace	33
4.10.2.4	Opening a Workspace.....	34

4.10.2.5	Deleting a Workspace / Export	34
4.10.2.6	Importing a Workspace	35
4.10.2.7	Exporting a Workspace	36
4.11	Auto Sequence® groups	37
4.11.1	<i>Auto Sequence® groups menu</i>	37
4.11.1.1	Operations in Auto Sequence® groups menu	38
4.11.1.2	Selecting a list of Auto Sequences®	38
4.11.1.3	Deleting a list of Auto Sequences®	39
5	Memory Organizer	40
5.1	Memory Organizer menu	40
5.1.1	<i>Measurement statuses</i>	40
5.1.2	<i>Structure Objects</i>	41
5.1.2.1	Measurement status indication under the Structure object	41
5.1.3	<i>Selecting an active Workspace in Memory Organizer</i>	42
5.1.4	<i>Adding Nodes in Memory Organizer</i>	43
5.1.5	<i>Operations in Tree Menu</i>	44
5.1.5.1	Operations on measurements (finished or empty measurements)	44
5.1.5.2	Operations on Structure objects	45
5.1.5.3	View / Edit parameters and attachments of a Structure object	47
5.1.5.4	Add a new Structure Object	49
5.1.5.5	Add a new measurement	51
5.1.5.6	Clone a Structure object	53
5.1.5.7	Clone a measurement	54
5.1.5.8	Copy & Paste a Structure object	54
5.1.5.9	Copy & Paste a measurement	56
5.1.5.10	Delete a Structure object	57
5.1.5.11	Delete a measurement	57
5.1.5.12	Rename a Structure object	58
5.1.5.13	Recall and Retest selected measurement	59
5.1.6	<i>Searching in Memory Organizer</i>	60
6	Single tests	63
6.1	Selection modes	63
6.1.1	<i>Single test screens</i>	64
6.1.1.1	Single test start screen	65
6.1.1.2	Setting parameters and limits of single tests	66
6.1.1.3	Single test screen during test	67
6.1.1.4	Single test result screen	68
6.1.1.5	Single test memory screen	69
6.1.2	<i>Single test (inspection) screens</i>	70
6.1.2.1	Single test (inspection) start screen	70
6.1.2.2	Single test (Inspection) screen during test	71
6.1.2.3	Single test (Inspection) result screen	72
6.1.2.4	Single test (inspection) memory screen	73
6.1.3	<i>Help screens</i>	74
6.2	Single test measurements	75
6.2.1	<i>Visual inspection</i>	75
6.2.2	<i>Continuity // Protective earth resistance</i>	76
6.2.2.1	Compensation of test lead / IEC test cable resistance	78
6.2.3	<i>Flash test</i>	79
6.2.4	<i>Insulation resistance (Riso, Riso-S)</i>	81
6.2.5	<i>Sub-leakage (Isub, Isub-S)</i>	82
6.2.6	<i>Differential Leakage</i>	84
6.2.7	<i>Ipe Leakage</i>	86

6.2.8	Touch Leakage	87
6.2.9	Power	89
6.2.10	Leak's & Power	90
6.2.11	PRCD test	91
6.2.12	RCD test	93
6.2.13	PE conductor (PRCD)	95
6.2.14	Open conductor (PRCD)	96
6.2.15	PRCD PE probe test	97
6.2.16	Polarity	99
6.2.17	Clamp current	101
6.2.18	Insulation resistance – Riso (welding equipment)	103
6.2.19	Welding Circuit Leakage – I leak (W-PE)	104
6.2.20	Primary Leakage	105
6.2.21	No-load voltage	106
6.2.22	Insulation resistance – Riso (medical equipment)	107
6.2.23	Equipment Leakage (medical equipment)	110
6.2.24	Applied Part Leakage (medical equipment)	113
6.2.25	Touch Current (medical equipment)	115
6.2.26	Functional test	117
7	Auto Sequences®	118
7.1	Selection of Auto Sequences®	118
7.1.1	Selecting an active Auto Sequence® group in Auto Sequences® menu	118
7.1.2	Searching in Auto Sequences® menu	119
7.1.3	Organization of Auto Sequences® in Auto Sequences® menu	121
7.2	Organization of an Auto Sequence®	122
7.2.1	Auto Sequence® view menu	122
7.2.1.1	Auto Sequence® view menu (Header is selected)	122
7.2.1.2	Auto Sequence® view menu (measurement is selected)	123
7.2.1.3	Indication of Loops	124
7.2.1.4	Managing multiple points	124
7.2.2	Step by step execution of Auto Sequences®	124
7.2.3	Auto Sequence® result screen	126
7.2.4	Auto Sequence® memory screen	128
7.2.5	Print label menu	129
8	Maintenance	130
8.1	Periodic calibration	130
8.2	Fuses	130
8.3	Service	130
8.4	Cleaning	130
9	Communications	131
9.1	USB and RS232 communication with PC	131
9.2	Bluetooth communication	131
9.3	Bluetooth communication with printers and scanners	132
9.4	RS232 communication with other external devices	132
9.5	Connections to test adapters	132
9.5.1	Active 3 Phase Adapter /Plus (A 1322 / A 1422)	132
9.5.2	110 V Test Adapter (A 1474)	133
10	Technical specifications	134
10.1	Continuity // Protective earth resistance	134
10.2	Insulation Resistance (Riso, Riso-S)	134
10.3	Sub-Leakage Current, Substitute Leakage Current - S	135

10.4	Differential Leakage current	135
10.5	PE leakage current	135
10.6	Touch leakage current.....	136
10.7	Power.....	136
10.8	Leak's & Power.....	137
10.9	PRCD test.....	139
10.10	RCD test	139
10.11	PE conductor (PRCD)	140
10.12	Open conductor (PRCD)	140
10.13	PRCD PE probe test.....	140
10.14	Polarity	141
10.15	Clamp current	141
10.16	Flash test	141
10.17	Insulation resistance Riso (welding equipment)	142
10.18	Welding Circuit leakage (I _{leak} W-PE)	142
10.19	Primary Leakage (I _{diff})	142
10.20	No-load voltage.....	142
10.21	Insulation Resistance (medical equipment)	143
10.22	Equipment leakage.....	143
10.23	Applied Part leakage	144
10.24	Touch current (medical equipment)	144
10.25	General data	145
Appendix A	Structure objects in OmegaPAT XA.....	146
Appendix B	Profile Notes.....	147
Appendix C	Print labels and write / read RFID / NFC tags.....	148
C.1	PAT tag format.....	148
C.2	Generic tag format.....	150
Appendix D	Default list of Auto Sequences®.....	152
Appendix E	Programming of Auto Sequences® on Metrel ES Manager	153
E.1	Auto Sequence® Editor workspace	153
E.2	Managing groups of Auto Sequences®	154
E.2.1	Auto Sequence® Name, Description and Image editing	156
E.2.2	Search within selected Auto Sequence® group	157
E.3	Elements of an Auto Sequence®	158
E.3.1	Auto Sequence® steps.....	158
E.3.2	Single tests	158
E.3.3	Flow commands.....	158
E.3.4	Number of measurement steps.....	158
E.4	Creating / modifying an Auto Sequence®.....	158
E.5	Description of flow commands	159
E.6	Custom Inspections programming	162
E.6.1	Creating and editing Custom Inspections	162
E.6.2	Applying Custom Inspections	164

1 General description

1.1 Warnings and notes



1.1.1 Safety warnings

In order to reach high level of operator safety while carrying out various measurements using the OmegaPAT XA instrument, as well as to keep the test equipment undamaged, it is necessary to consider the following general warnings:

- › **Read this user manual carefully, otherwise use of the instrument may be dangerous for the operator, for the instrument or for the equipment under test!**
- › **Consider warning markings on the instrument!**
- › **If the test equipment is used in manner not specified in this user manual the protection provided by the equipment may be impaired!**
- › **Do not use the instrument and accessories if any damage is noticed!**
- › **Regularly check the instrument and accessories for correct functioning to avoid hazard that could occur from misleading results.**
- › **Consider all generally known precautions in order to avoid risk of electric shock while dealing with hazardous voltages!**
- › **Use only standard or optional test accessories supplied by your distributor!**
- › **Only test equipment provided or approved by Metrel should be connected to 3-PHASE ADAPTER connector.**
- › **Do not connect external voltage to CLAMP inputs. It is intended only for connection of Clamps approved by Metrel.**
- › **Use only earthed mains outlets to supply the instrument!**
- › **If working on other than 230 V TN/TT voltage systems refer to chapter 1.2.1 230 V / 110 V operation.**
- › **In case a fuse has blown refer to chapter 8.2 Fuses to replace it!**
- › **Instrument servicing and calibration is allowed to be carried out only by a competent authorized person!**
- › **LCD screenshots in this document are informative only. Screens on the instrument may be slightly different.**

1.1.2 Warnings related to safety of measurement functions

1.1.2.1 Flash HV

- › A voltage of up to 3 kV_{AC} between FLASH and mains socket LN terminals / 1.5 kV_{AC} between main socket's LN and PE socket terminals / 1.5 kV_{AC} between FLASH and mains socket PE terminal is applied to the instrument's outputs during the test. Although the current of the HV source is limited to safe level special safety consideration must be taken when performing this test!





1.1.2.2 Differential leak., Ipe leak., Touch leak., Ileak (W-PE), Primary leak., Power, Leak's & Power, Equipment leak., Applied part leak.

- › Load currents higher than 10 A can result in high temperatures of fuse holders! It is advisable not to run tested devices with load currents above 10 A for more than 15 minutes. Recovery period for cooling is required before proceeding with tests! Maximum intermittent duty cycle for measurements with load currents higher than 10 A is 50 %.

1.1.2.3 Insulation resistance

- › Do not touch the test object during the measurement or before it is fully discharged!
Risk of electric shock!

1.1.3 Markings on the instrument

- ›  Read the Instruction manual with special care to safety operation«. The symbol requires an action!
- ›  Dangerous high voltage is present on terminals during the test. Consider all precautions in order to avoid risk of electric shock.
- ›  Mark on your equipment certifies that it meets European Union requirements for EMC, LVD, and ROHS regulations.
- ›  This equipment should be recycled as electronic waste.

1.2 Power management

1.2.1 230 V / 110 V operation

The instrument works on 110 V and 230 V mains. 110 V and 230 V appliances can be fully tested.

In UK and Aus/Nz models only 110 V mains voltage will be applied to the mains test socket if the 110 V test adapter (A 1474) is connected to the instrument.

1.2.2 Battery and charging, auto power off

The instrument has an in-built rechargeable battery pack. The battery is charged whenever the instrument is connected to the mains. When the instrument is disconnected from mains, the battery provides power to the instrument to stay energized for 1 minute. This is indicated by the battery symbol in the upper right corner of the LCD. Operation with the instrument is not possible except the mains was disconnected during the RCD test. As long as the instrument is energized it will be ready to use immediately after connected to mains voltage again. This enables faster testing of appliances.

If the instrument is not reconnected to mains within 1 minute it will completely switch off. When connected to mains again, a normal power up procedure will be taken.



Figure 1.1: Indication of battery status

Notes:

- › A flat or faulty battery will result in an immediate power off after the instrument is disconnected from the mains.
- › Charging time of the battery is about 14 h.

1.2.3 Power Off, Restart

Instrument is powered by battery:

- › when pressing the ESC key for ca 5 s the instrument will switch off.

Instrument is connected to mains:

- › when pressing the ESC key for ca 5 s the instrument will restart.

1.3 Standards applied

The OmegaPAT XA instrument is manufactured and tested according to the following regulations, listed below.

Electromagnetic compatibility (EMC)

EN 61326-1	Electrical equipment for measurement, control and laboratory use - EMC requirements – Part 1: General requirements Class B (Portable equipment used in controlled EM environments)
------------	---

Safety (LVD)

EN 61010-1	Safety requirements for electrical equipment for measurement, control, and laboratory use – Part 1: General requirements
EN 61010-2-030	Safety requirements for electrical equipment for measurement, control and laboratory use – Part 2-030: Particular requirements for testing and measuring circuits
EN 61010-031	Safety requirements for electrical equipment for measurement, control and laboratory use – Part 031: Safety requirements for hand-held probe assemblies for electrical measurement and test
EN 61010-2-032	Safety requirements for electrical equipment for measurement, control and laboratory use – Part 2-032: Particular requirements for hand-held and hand-manipulated current sensors for electrical test and measurement
EN 61557	Electrical safety in low voltage distribution systems up to 1 000 V a.c. and 1 500 V d.c. – Equipment for testing, measuring or monitoring of protective measures Instrument complies with all relevant parts of EN 61557 standards.

Functionality

Code of Practice	Household and similar electrical appliances Inspection after repair, modification of electrical appliances – Periodic inspection on electrical appliances
VDE 0701-702	General requirements for electrical safety
IEC/EN 60974-4	Arc welding equipment – Part 4: Periodic inspection and testing
IEC/EN 62353	Medical electrical equipment - Recurrent test and test after repair of medical electrical equipment
AS/NZS 3760	In-service safety inspection and testing of electrical equipment

2 Instrument set and accessories

2.1 Standard set of the instrument

- › Instrument MI 3360 OmegaPAT XA
- › Bag for accessories
- › Flash test probe (MI 3360 F only)
- › IEC test cable 3 x 1.5 mm², 2 m
- › Test lead (black)
- › Test tip (black)
- › Alligator clip (black)
- › Mains cable, 3 x 1.5 mm², 2 m
- › USB cable
- › Calibration Certificate
- › Short form instruction manual
- › CD with instruction manual (full version) and PC SW Metrel ES Manager

2.2 Optional accessories

See the attached sheet for a list of optional accessories that are available on request from your distributor.

3 Instrument description

3.1 Front panel

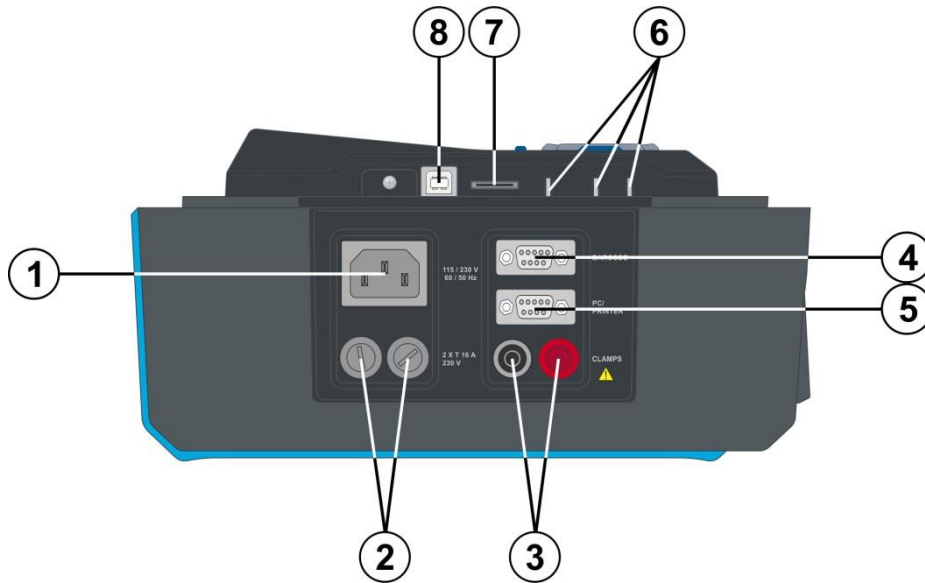


Figure 3.1: Left side panel

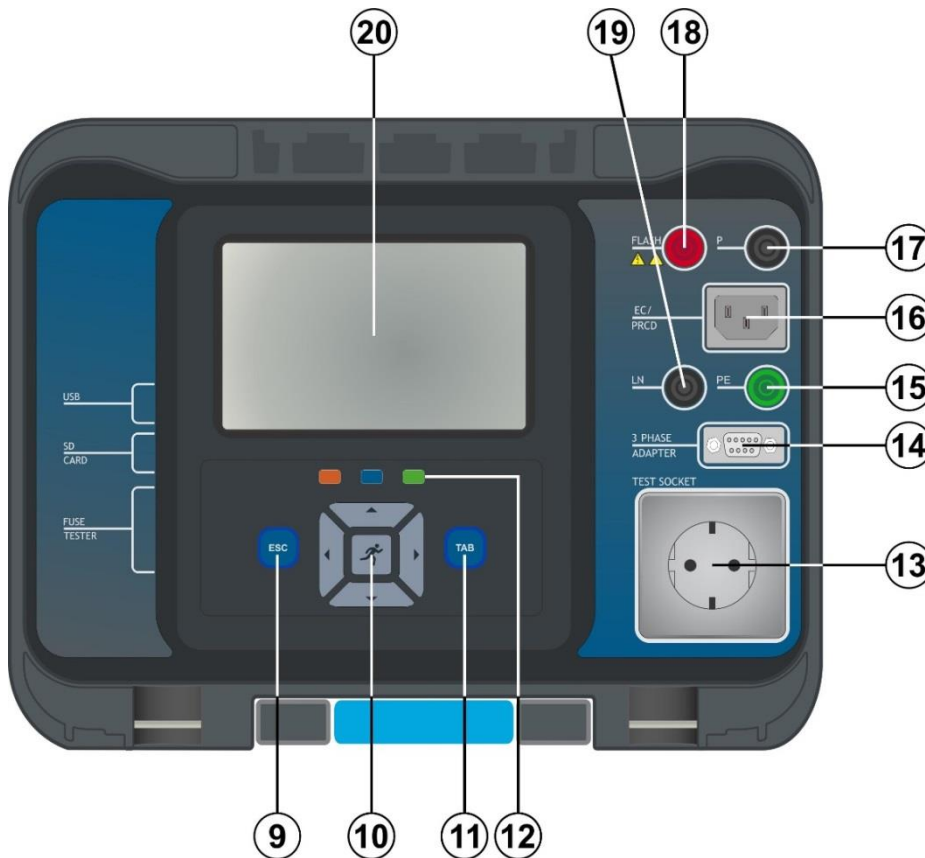


Figure 3.2: Front panel

1	Mains supply connector
2	F1, F2 fuses (T 16 A / 250 V)
3	Clamp inputs
4	Barcode scanner and RFID / NFC reader / writer device serial port
5	PC / Printer serial port
6	Fuse checker
7	MicroSD card slot
8	USB communication port
9	Escape key / reset key
10	Keypad
11	TAB key
12	Shortcut keys
13	Mains test socket
14	Data connection 3 phase adapter
15	PE connector
16	IEC test connector
17	P/S (probe) connector, P/AP (probe / applied part) connector
18	FLASH output connector
19	LN connector
20	Colour TFT display with touch screen

4 Instrument operation

The instrument can be manipulated via a keypad or touch screen.

4.1 General meaning of keys



Cursor keys are used to:

- select appropriate option



RUN key is used to:

- confirm selected option
- start and stop measurements



Escape key is used to:

- return to previous menu without changes
- abort measurements
- reset instrument (long press >5 sec)
- switch OFF instrument from standby mode (long press >5 sec)



Option key is used to:

- expand column in control panel
- show detailed view of options



Shortcut keys for immediate access to the Memory Organizer, Auto Sequences® menu and Single Tests menu.

4.2 General meaning of touch gestures



Tap (briefly touch surface with fingertip) is used to:

- select appropriate option
- confirm selected option
- start and stop measurements



Swipe (press, move, lift) up/ down is used to:

- scroll content in same level
- navigate between views in same level



long

Long press (touch surface with fingertip for at least 1 s) is used to:

- select additional keys (virtual keyboard)
- enter cross selector from single test screens



Tap Escape icon is used to:










- return to previous menu without changes;
- abort / stop measurements

4.3 Virtual keyboard



Figure 4.1: Virtual keyboard

Options:

	Toggle case between lowercase and uppercase. Active only when alphabetic characters' keyboard layout selected.
	Backspace Clears last character or all characters if selected. (If held for 2 s, all characters are selected).
	Enter confirms new text.
	Activates numeric / symbols layout.
	Activates alphabetic characters.
	English keyboard layout.
	Greek keyboard layout.
	Russian keyboard layout.
	Returns to the previous menu without changes.

4.4 Safety checks

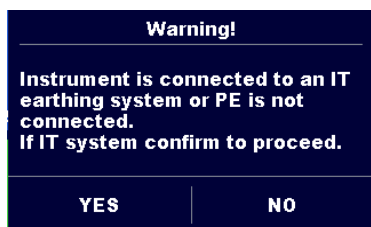
At start up and during operation the instrument performs various safety checks to ensure safety and to prevent any damage. These safety pre-tests are checking for:

- › Correct input mains voltage
- › Presence of input PE connection,

- › Any external voltage against earth on mains test socket
- › Excessive leakage currents through measuring I/O's,
- › Too low resistance between L and N of tested device,
- › Proper operation of safety relevant internal electronic circuits

If a safety check fails, an appropriate warning message will be displayed and safety measures will be taken. The warnings and safety measures are described in chapter 4.5 Symbols and messages.

4.5 Symbols and messages



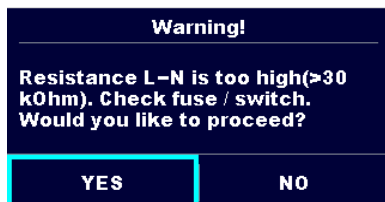
Supply voltage warning

Possible causes:

- › No earth connection.
- › Instrument is connected to an IT earthing system. Press YES to continue normally or NO to continue in a limited mode (measurements are disabled).

Warning:

The instrument must be earthed properly to work safely!



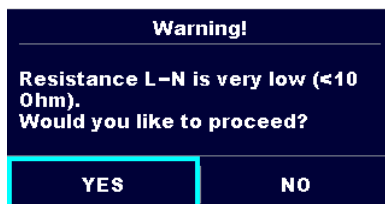
Resistance L-N > 30 kΩ

In pre-test a high input resistance was measured.

Possible causes:

- › Device under test is not connected or switched on
- › Input fuse of device under test is blown.

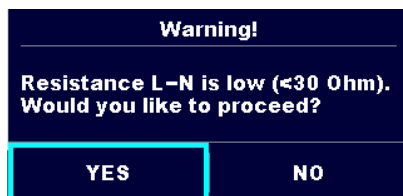
Select **YES** to proceed with or **NO** to cancel measurement.



Resistance L-N < 10 Ω

In pre-test a very low resistance of the device under test supply input was measured. This can result in a high current after applying power to the device under test. If the too high current is only of short duration (caused by a short inrush current) the test can be performed otherwise not.

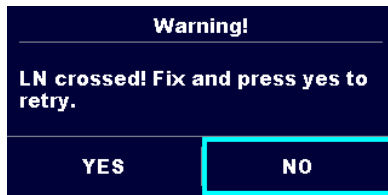
Select **YES** to proceed with or **NO** to cancel measurement



Resistance L-N < 30 Ω

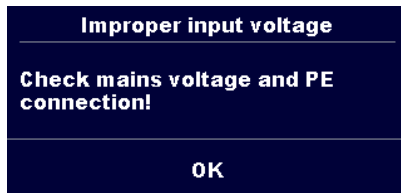
In pre-test a low input resistance of the device under test was measured. This can result in a high current after applying power to the device. If the high current is only of short duration (caused by a short inrush current) the test can be performed, otherwise not.

Select **YES** to proceed with or **NO** to cancel measurement.

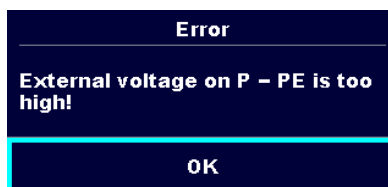


Warning for proper connection in some PRCD measurements. Connection of PRCD's plug must be changed in order to proceed.

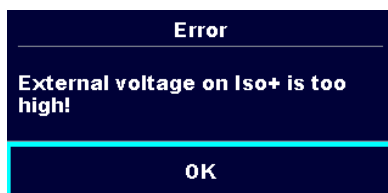
Select **YES** to retry after reconnection with or **NO** to cancel measurement.



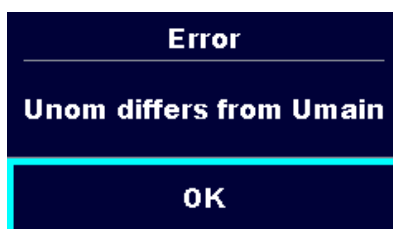
Warning for improper supply voltage condition. If pressing OK instrument will continue to work in a limited mode (measurements are disabled).



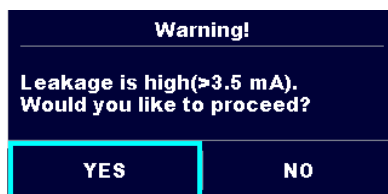
In pre-test a too high external voltage was detected between P and PE terminals. The measurement was cancelled. Press OK to continue.



In pre-test a too high external voltage was detected between LN and PE terminals. The measurement was cancelled. Press OK to continue.



The set Unom differs too much from the measured mains voltage. Parameter or mains voltage must be changed.

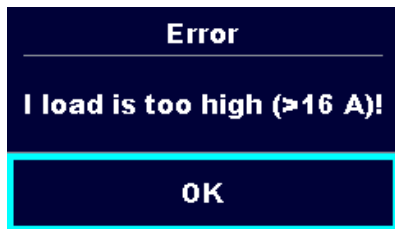


In pre-test a possible high leakage current was detected. It is likely that a dangerous leakage current (higher than 3.5 mA) will flow after applying power to the device under test.

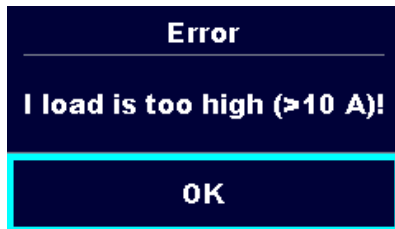
Select **YES** to proceed with or **NO** to cancel measurement.



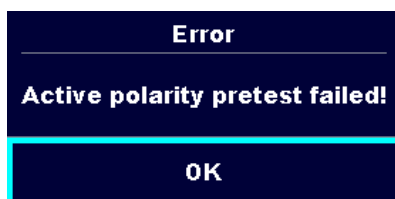
The measured leakage (Idiff, Ipe, Itouch) current was higher than 20 mA. Measurement was aborted. Press OK to continue.



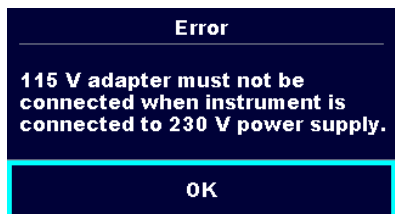
The load current higher than 16 A is detected. Measurement is aborted. Press OK to continue.



The average load current higher than 10 A over the last 5 min test interval is detected. Measurement is stopped. Recovery period for cooling is required before proceeding with tests! Press OK to continue.



The polarity pre-test of the cable / PRCD has failed. Press OK to continue.



Instrument prohibits the test because 115 V adapter is connected to the instrument and the instrument is powered with 230 V.



The instrument is overheated. The measurement can't be carried out until the icon disappears. Press OK to continue.



The device under test should be switched on (to ensure that the complete circuit is tested).



In case of simultaneously measuring of Riso, Riso-S or Isub, Isub-S. If the voltage has dropped because of one measurement the other measurement is also compromised.



Red dot indicates phase of measurement where higher leakage was measured. Applicable only if phase reversal is enabled during the measurement.



Warning!

A high voltage is / will be present on the instrument output! (Withstanding test voltage, Insulation test voltage, or mains voltage).

**Warning!**

A very high voltage is / will be present on the instrument output! (Flash test voltage).



Test leads resistance in Continuity / Protective Earth measurement is not compensated.



Test leads resistance in Continuity / Protective Earth measurement is compensated.



Measurement can't be started. 3 phase adapter should be disconnected from the instrument.



Measurement in combination with appropriate 3 phase adapter can be carried out.



The measurement can be carried out only in combination with appropriate 3 phase adapter.



Test passed.



Test failed.



Conditions on the input terminals allow starting the measurement; consider other displayed warnings and messages.



Conditions on the input terminals do not allow starting the measurement, consider displayed warnings and messages.



Stop the measurement.

4.6 Instrument main menu

From the instrument Main Menu different main operation menus can be selected.

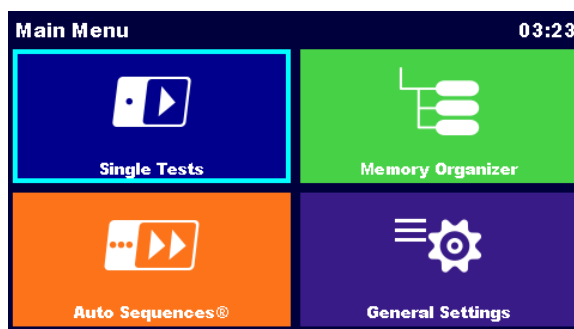


Figure 4.2: Main menu

Options



Single Tests

Menu with single tests, see chapter 0 **Error! Not a valid result for able..**



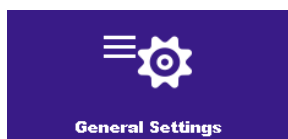
Auto Sequences®

Menu with customized test sequences, see chapter 7 *Auto Sequences®*.



Memory Organizer

Menu for working with and documentation of test data, see chapter 5 *Memory Organizer*.



General Settings

Menu for setup of the instrument, see chapter 4.7 *General settings*.

4.7 General settings

In the General Settings menu general parameters and settings of the instrument can be viewed or set.

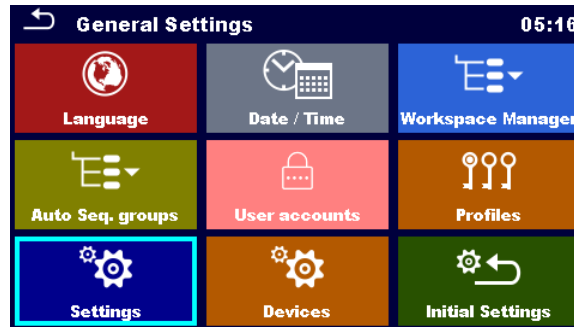












Figure 4.3: Setup menu

Options in General Settings menu

	Language Instrument language selection.
	Date / Time Instruments Date and time.
	Workspace Manager Manipulation with project files. Refer to chapter 4.10 <i>Workspace Manager</i> for more information.
	Auto Sequence® groups Manipulation with lists of Auto Sequences®. Refer to chapter 4.11 <i>Auto Sequence® groups</i> for more information.
	User accounts User account settings.
	Profiles Selection of available instrument profiles.
	Settings Setting of different system / measuring parameters.
	Devices Setting of external devices.
	Initial Settings Factory settings.
	About Basic instrument data.

4.7.1 Language

In this menu the language of the instrument can be set.



Figure 4.4: Select language menu

4.7.2 Date and time

In this menu date and time of the instrument can be set.

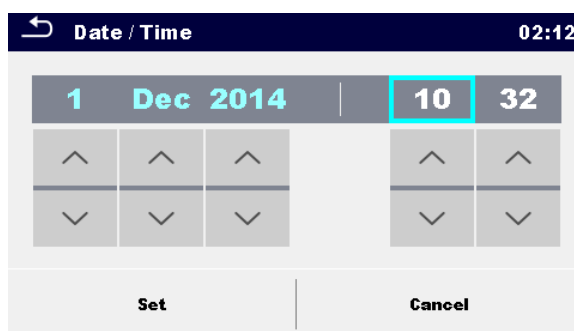


Figure 4.5: Setting data and time menu

4.7.3 Profiles

Refer to *Chapter 4.9 Instrument profiles* for more information.

4.7.4 Workspace Manager

Refer to *Chapter 4.10 Workspace Manager* for more information.

4.7.5 Auto Sequence® groups

Refer to *Chapter 4.11 Auto Sequence® groups* for more information.

4.7.6 Settings

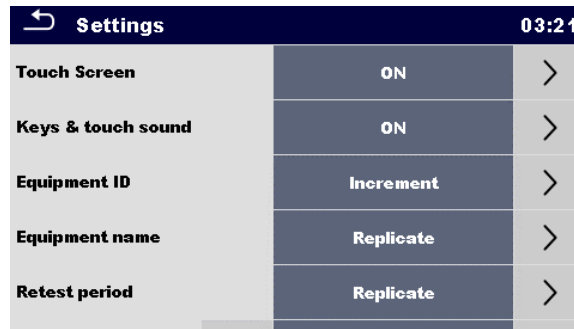


Figure 4.6: Settings menu

Setting options:

	Description
Touch screen	ON – touch screen is active. OFF – touch screen is deactivated.
Keys & touch sound	ON – sound is active. OFF – sound is deactivated.
Equipment ID	Increment – offered ID will be incremented +1. Replicate – offered ID will be the same as last used. Blank – equipment ID will not be offered.
Equipment name	Replicate – offered name will be the same as last used. Blank – equipment name will not be offered.
Retest period	Replicate – offered retest period will be the same as last used. Blank – retest period will not be offered.
Unom	Nominal Line to earth voltage [100 V, 110 V, 120 V, 220 V, 230 V or 240 V] (is used for normalization of leakage current results if testing medical equipment).
RCD Standard	Selection of appropriate standard for RCD tests.
PRCD Standard	Selection of appropriate standard for PRCD tests.
Ch_1 clamp type	Setting of current clamp type.
Result	In case the measurement consists of multiple measurements taken successively, the worst or the last result can be displayed at the end. Worst – the worst result will be displayed at the end of test. Last – last result will be displayed at the end of test. Notes: <ul style="list-style-type: none"> ▸ In general the worst result(s) of the main result is considered. Sub-result(s) taken at the same time as the worst case of the main result are displayed. ▸ In the function Leak's & Power the worst case of Idiff and I touch

	<p>are considered. The Power result measured at the time of worst Idiff is displayed.</p> <ul style="list-style-type: none"> ‣ In the function Riso, Riso-S the worst case of Riso and Riso-S are considered. The Um result measured at the time of worst Riso is displayed. ‣ For the Power measurement the last result is considered regardless of the Result setting.
Limit Uc	Conventional touch voltage limit [25 V, 50 V]

4.7.7 Initial Settings

In this menu internal Bluetooth module can be initialized and the instrument settings, measurement parameters and limits can be set to initial (factory) values.

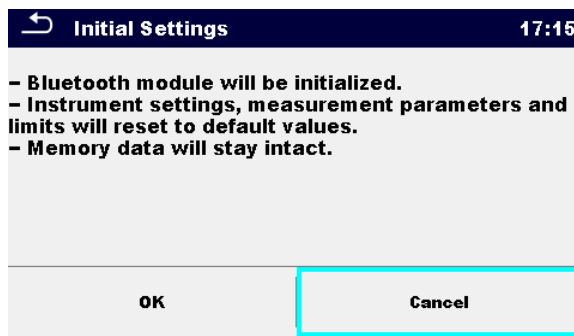


Figure 4.7: Initial settings menu

Warning!

Following customized settings will be lost when setting the instruments to initial settings:

- Measurement limits and parameters
- Global parameters, System settings and Devices in General settings menu
- Opened Workspace and Auto Sequence® group will be deselected.
- User will be signed out.

Note:

Following customized settings will stay:

- Profile settings
- Data in memory (Data in Memory organizer, Workspaces, Auto Sequence® groups and Auto Sequences®)
- User accounts

4.7.8 About

In this menu instrument data (name, serial number, FW and HW version and date of calibration) can be viewed.

About		14:14
Name	MI 3360 OmegaPAT XA	
S/N	12344321	
FW version	0.14.0.6774 - A0AA	
HW version	1.0	
Date of calibration	19.Jul.2016	
(C) Metrel d.d., 2016, http://www.metrel.si		

Figure 4.8: Instrument info screen

Note:

- › Adapter info is also displayed if connected.

4.7.9 User Accounts

The demand to sign in can prevent from unauthorized persons to work with the instrument. In this menu user accounts can be managed:

- › Setting if signing in to work with the instrument is required or not.
- › Adding and deleting new users, setting their user names and passwords.

The user accounts can be managed by the administrator.

Factory set administrator password: ADMIN

It is recommended to change factory set administrator password after first use. If the custom password is forgotten the second administrator password can be used. This password always unlock the Account manager and is delivered with the instrument.

If an user account is set and the user is signed in the user's name will be stored in memory for each measurement.

Individual users can change their passwords.

4.7.9.1 Signing in

If signing in is demanded the user must enter the password in order to work with the instrument.

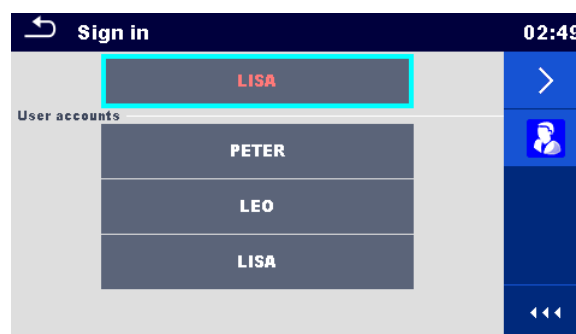
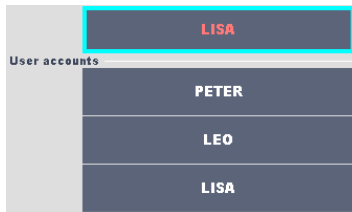


Figure 4.9: Sign in menu

Options

User signing in



The user should be selected first. The last used user is displayed in the first row.



Goes to Password entry menu.



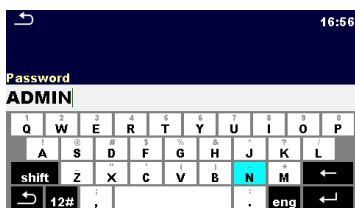
To sign in, the selected user password must be entered and confirmed.

The user password consist of a up to 4 digit number.

Administrator signing in



Enters Account manager menu.



The administrator password must be entered and confirmed first.

Administrator password consists of letters and/or numbers. Letters are case sensitive.

4.7.9.2 Changing user password, signing out

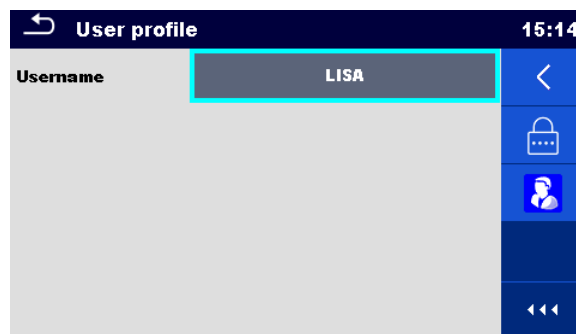


Figure 4.10: User profile menu

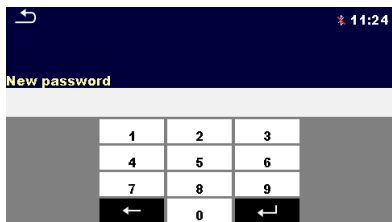
Options



Signs out the set user.



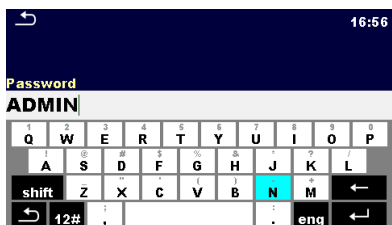
Enters procedure for changing the user’s password.



The actual password must be entered first followed by the new password.



Enters the Account manager menu.



The Account manager menu is accessed by selecting Account Manager in Sign in menu or User profile menu. The administrator password must be entered and confirmed first. The factory set default administrator password is: ADMIN

4.7.9.3 Managing accounts

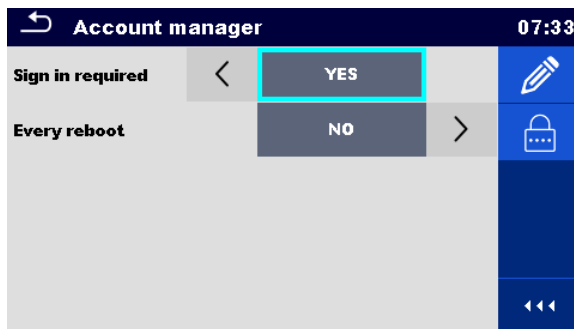


Figure 4.11: Account manager menu

Options



Field for setting if signing in is required to work with the instrument.

Field for setting if signing is required once or at each power on of the instrument.



Enters procedure for changing the administrator password.



The actual password must be entered first followed by the new password.



Enters menu for editing user accounts.

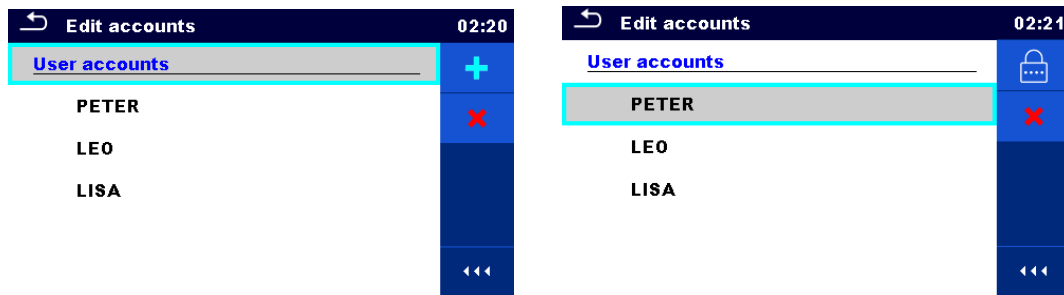
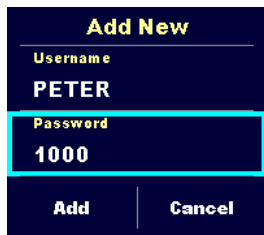


Figure 4.12: Edit accounts menu

Options



Opens the window for adding a new user account.



In the Add New window the name and initial password of the new user account are to be set. 'Add' confirms the new user account.



Changes password of the selected user account.



Deletes all user accounts.
Deletes the selected user account.

4.8 Devices

In this menu operation with external devices is configured.

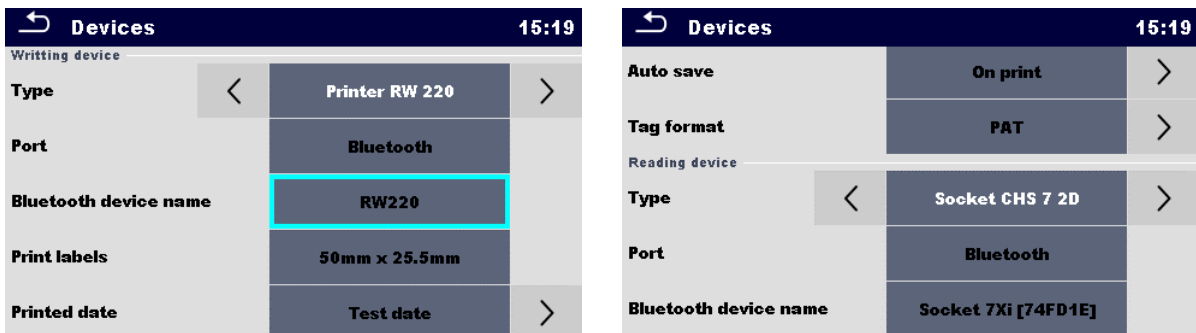


Figure 4.13: Devices settings menu

Writing devices	
Type	Sets appropriate writing device (Serial printer, Bluetooth printer), RFID writer).
Port	Sets/views communication port of selected writing device.
Bluetooth device name	Goes to menu for pairing with selected Bluetooth device.
Bluetooth dongle	Initializes Bluetooth Dongle.
Print labels	Selects label form size. See for details.
Printed date	Selects date printed on label text area, Options: [Test date, Retest date]. See <i>Appendix C Print labels and write / read RFID / NFC tags</i> for details.
Auto save	Sets simultaneous saving of finished Auto Sequence when label is printed or RFID / NFC tag is written. Options: [On print, On write, OFF] See chapter <i>7.2.3 Auto Sequence® result screen</i> for details.
Tag format	Sets PAT tag / label format or generic tag /label format. See <i>Appendix C Print labels and write / read RFID / NFC tags</i> for details.
Reading devices	
Type	Sets appropriate reading device (QR or barcode scanner, RFID reader, android device via aMESM application).
Port	Sets/views communication port of selected reading device.
Bluetooth device name	Goes to menu for pairing with selected Bluetooth device.

4.9 Instrument profiles

In this menu the instrument profile can be selected from the available ones.

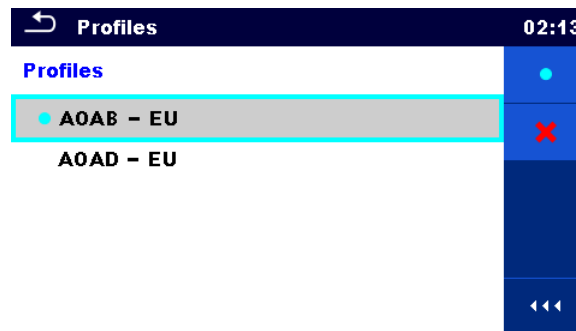


Figure 4.14: Instrument profile menu

The instrument uses different specific system and measuring settings in regard to the scope of work or country it is used. These specific settings are stored in instrument profiles.

By default each instrument has at least one profile activated. Proper licence keys must be obtained to add more profiles to the instrument.

If different profiles are available they can be selected in this menu.

Refer to *Appendix B Profile Notes* for more information about functions specified by profiles.

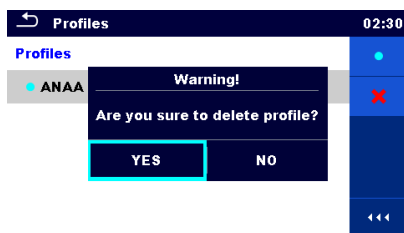
Options



Loads the selected profile. The instrument will restart automatically with new profile loaded.



Enters option for deleting a profile.



Before deleting the selected profile user is asked for confirmation.

4.10 Workspace Manager

The Workspace Manager is intended to manage with different Workspaces and Exports stored on the microSD card.

4.10.1 Workspaces and Exports

The works with OmegaPAT XA MI 3360 can be organized with help of Workspaces and Exports. Exports and Workspaces contain all relevant data (measurements, parameters, limits, structure objects) of an individual work.

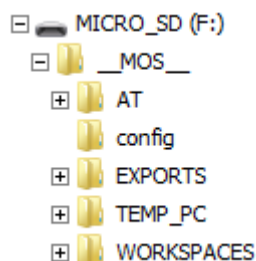


Figure 4.15: Organization of Workspaces and Exports on microSD card

Workspaces are stored on microSD card on directory WORKSPACES, while Exports are stored on directory EXPORTS. Export files can be read by Metrel applications that run on other devices. Exports are suitable for making backups of important works or can be used for storage of works if the removable microSD card is used as a mass storage device. To work on the instrument an Export should be imported first from the list of Exports and converted to a Workspace. To be stored as Export data a Workspace should be exported first from the list of Workspaces and converted to an Export.






4.10.2 Workspace Manager main menu

In Workspace manager Workspaces and Exports are displayed in two separated lists.



Figure 4.16: Workspace manager main menu

Options

	
	List of Workspaces. Displays a list of Exports.
	Adds a new Workspace. Refer to Chapter 4.10.2.3 <i>Adding a new Workspace</i> for more information.
	List of Exports.
	Displays a list of Workspaces.

4.10.2.1 Operations with Workspaces

Only one Workspace can be opened in the instrument at the same time. The Workspace selected in the Workspace Manager will be opened in the Memory Organizer.

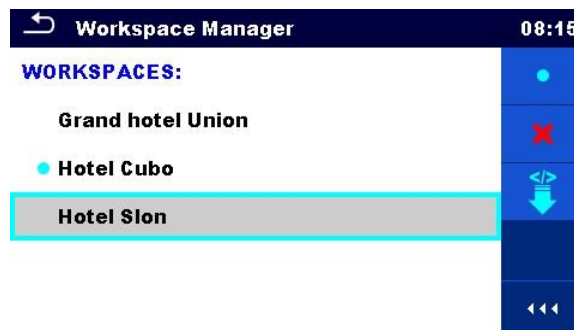







Figure 4.17: Workspaces menu

Options

	Marks the opened Workspace in Memory Organizer. Opens the selected Workspace in Memory Organizer. Refer to chapters 5 <i>Memory Organizer</i> and 4.10.2.4 <i>Opening a Workspace</i> for more information.
	Deletes the selected Workspace. Refer to chapter 4.10.2.5 <i>Deleting a Workspace / Export</i> for more information.
	Adds a new Workspace. Refer to chapter 4.10.2.3 <i>Adding a new Workspace</i> for more information.
	Exports a Workspace to an Export. Refer to chapter 4.10.2.7 <i>Exporting a Workspace</i> for more information.
	Opens options in control panel / expands column.

4.10.2.2 Operations with Exports



Figure 4.18: Workspace manager File menu

Options



Deletes the selected Export.

Refer to chapter 4.10.2.5 *Deleting a Workspace / Export* for more information.



Imports a new Workspace from Export.

Refer to chapter 4.10.2.6 *Importing a Workspace* for more information.



Opens options in control panel / expands column.

4.10.2.3 Adding a new Workspace

①

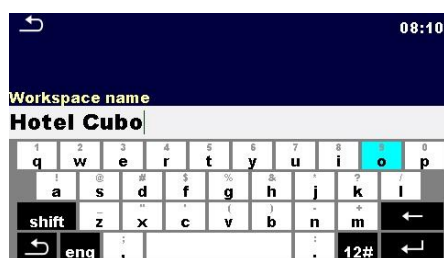


New workspaces can be added from the Workspace manager screen.

②



Enters option for adding new Workspace.



Keypad for entering name of a new Workspace is displayed after selecting New.



After confirmation a new Workspace is added in the list in Main Workspace Manager menu.

4.10.2.4 Opening a Workspace



Workspace can be selected from a list in Workspace manager screen.



Opens a Workspace in Workspace manager.



The opened Workspace is marked with a blue dot. The previously opened Workspace will close automatically.

4.10.2.5 Deleting a Workspace / Export

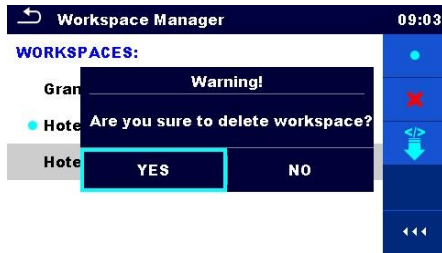


Workspace / Export to be deleted should be selected from the list of Workspaces / Exports.

Opened workspace can't be deleted.



Enters option for deleting a Workspace / Export.



Before deleting the selected Workspace / Export the user is asked for confirmation.



Workspace / Export is removed from the Workspace / Export list.

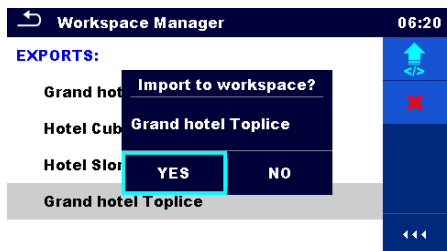
4.10.2.6 Importing a Workspace



Select an Export file to be imported from Workspace Manager Export list.



Enters option Import.



Before the import of the selected file the user is asked for confirmation.



The Imported Export file is added to the list of Workspaces.

Note:

If a Workspace with the same name already exists the name of the imported Workspace will be changed (name_001, name_002, name_003...).

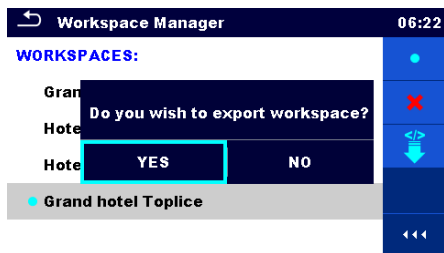
4.10.2.7 Exporting a Workspace



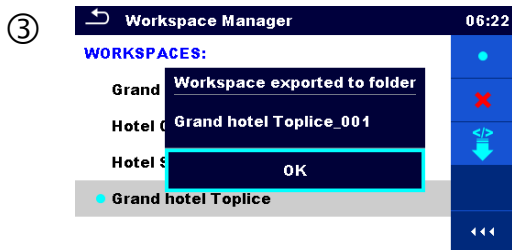
Select a Workspace from Workspace manager list to be exported to an Export file.



Enters option Export.



Before exporting the selected Workspace, the user is asked for confirmation.



Workspace is exported to Export file and is added to the list of Exports.

Note:

If an Export file with the same name already exists the name of the Export file will be changed (name_001, name_002, name_003, ...).



4.11 Auto Sequence® groups

The Auto Sequences® in OmegaPAT XA MI 3360 can be organized by using lists. In a list a group of similar Auto Sequences® is stored. The Auto Sequence® groups menu is intended to manage with different lists of Auto Sequences® that are stored on the microSD card.

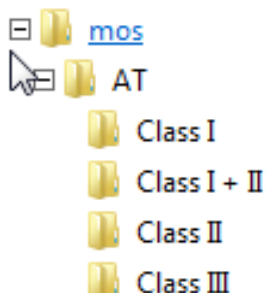


Figure 4.19: Organization of Auto Sequences® on microSD card

Folders with lists of Auto Sequences® are stored in *Root__MOS__\AT* on the microSD card.

4.11.1 Auto Sequence® groups menu

In Auto Sequence® groups menu lists of Auto Sequences® are displayed. Only one list can be opened in the instrument at the same time. The list selected in the Auto Sequence® groups menu will be opened in the Auto Sequences® main menu.

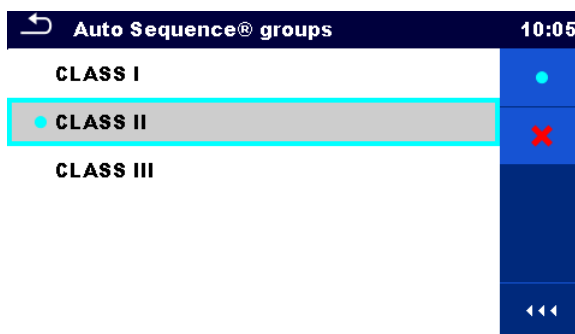
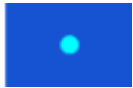


Figure 4.20: Auto Sequence® groups menu

4.11.1.1 Operations in Auto Sequence® groups menu

Options



Opens the selected list of Auto Sequences®. Previously selected list of Auto Sequences® will be closed automatically.

Refer to chapter 4.11.1.2 *Selecting a list of Auto Sequences®* for more information.



Deletes the selected list of Auto Sequences.

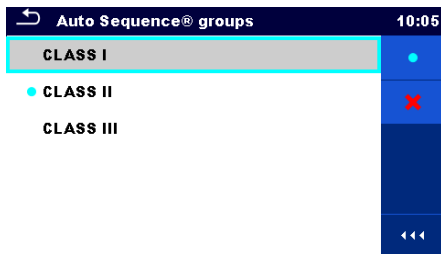
Refer to chapter 4.11.1.3 *Deleting a list of Auto Sequences®* for more information.



Opens options in control panel / expands column.

4.11.1.2 Selecting a list of Auto Sequences®

①

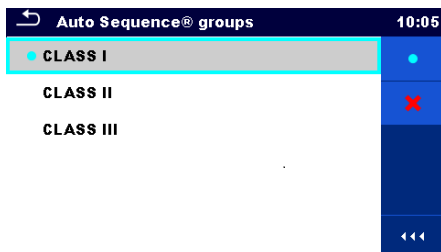


A list of Auto Sequences® can be selected from the Auto Sequence® groups menu.

②



Enters option for selecting a list.

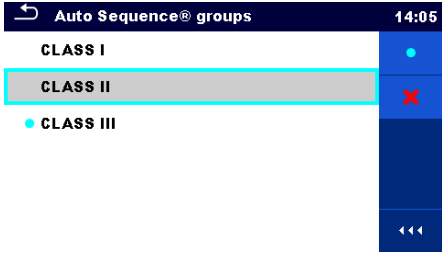

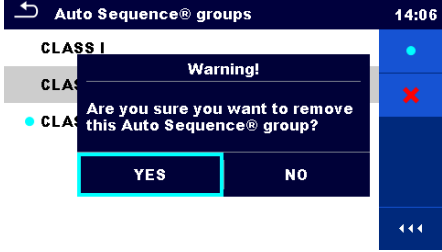
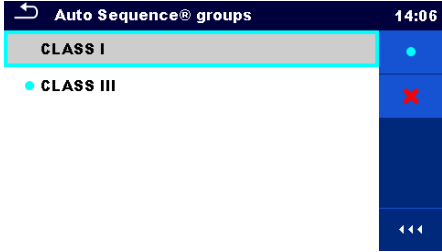


Selected list of Auto Sequences® is marked with a blue dot.

Note:

Previously selected list of Auto Sequences® is closed automatically.

4.11.1.3 Deleting a list of Auto Sequences®

-
- ①  A list of Auto Sequences® to be deleted can be selected from the Auto Sequence® groups menu.
-
- ②  Enters option for deleting a list.
- +  Before deleting the selected list of Auto Sequences® the user is asked for confirmation.
-
- ③  A list of Auto Sequences® is removed.
-

5 Memory Organizer

Memory Organizer is a tool for storing and working with test data.

5.1 Memory Organizer menu

The data is organized in a tree structure with Structure objects and Measurements. OmegaPAT XA has a multi-level structure. The hierarchy of Structure objects in the tree is shown on *Figure 5.1*. In *Appendix A Structure objects* in *OmegaPAT XA* is a list of available structure objects.

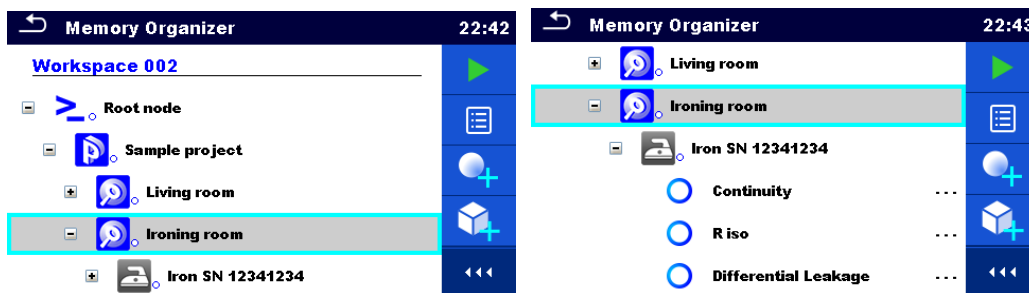


Figure 5.1: Tree structure and its hierarchy

5.1.1 Measurement statuses





Each measurement has:

- › a status (Pass or Fail or no status)
- › a name
- › results
- › limits and parameters

A measurement can be a Single test or an Auto Sequence.





For more information, refer to chapters *6 Single tests* and *7 Auto Sequences*®.

Statuses of Single tests

-  passed finished single test with test results
-  failed finished single test with test results
-  finished single test with test results and no status
-  empty single test without test results

Overall statuses of Auto Sequence

-  or  at least one single test in the Auto sequence passed and no single test failed
-  or  at least one single test in the Auto sequence failed

 or 	at least one single test in the Auto sequence was carried out and there were no other passed or failed single tests
 or 	empty Auto sequence with empty single tests

5.1.2 Structure Objects

Each Structure object has:

- › an icon
- › a name
- › parameters

Optionally they can have:

- › an indication of the status of the measurements under the Structure object
- › a comment or a file attached

Structure objects supported are described in *Appendix A Structure objects in OmegaPAT XA*.



Figure 5.2: Structure object in tree menu

5.1.2.1 Measurement status indication under the Structure object

Overall status of measurements under each structure element / sub-element can be seen without spreading tree menu. This feature is useful for quick evaluation of test status and as guidance for measurements.

Options



There are no measurement result(s) under selected structure object. Measurements should be made.

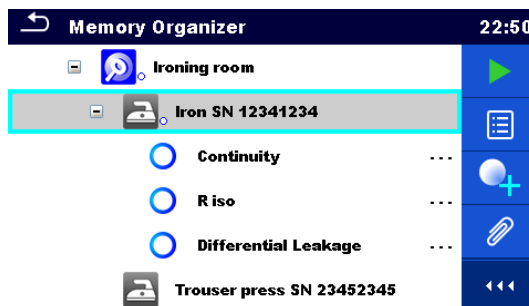
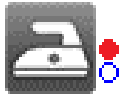


Figure 5.3: Example of status - No measurement result(s)



One or more measurement result(s) under selected structure object has failed. Not all measurements under selected structure object have been made yet.

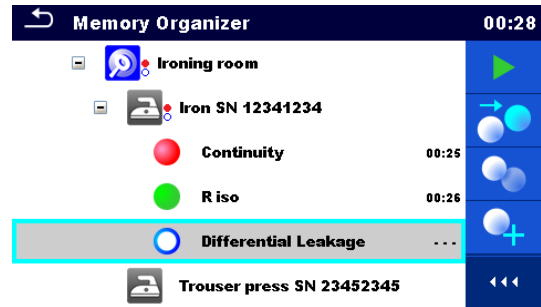


Figure 5.4: Example of status - Measurements not completed with fail result(s)



All measurements under selected structure object are completed but one or more measurement result(s) has failed.



Figure 5.5: Status - Measurements completed with fail result(s)

Note:

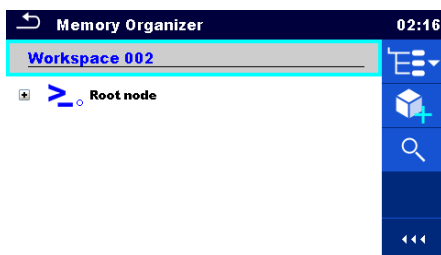
- There is no status indication if all measurement results under each structure element / sub-element have passed or if there is an empty structure element / sub-element (without measurements).

5.1.3 Selecting an active Workspace in Memory Organizer

Memory Organizer and Workspace Manager are interconnected so an active Workspace can be selected also in the Memory Organizer menu.

Procedure

①

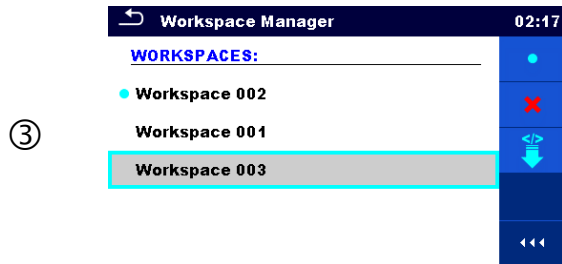


Press the active Workspace in Memory Organizer Menu.

②



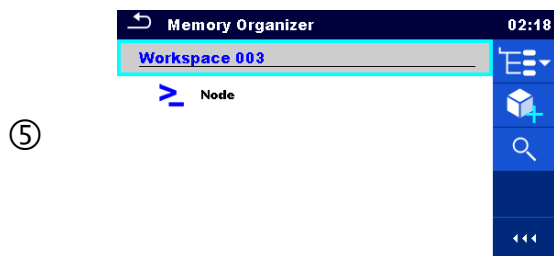
Select List of Workspaces in Control panel.



Choose desired Workspace from a list of Workspaces.



Use Select button to confirm selection.

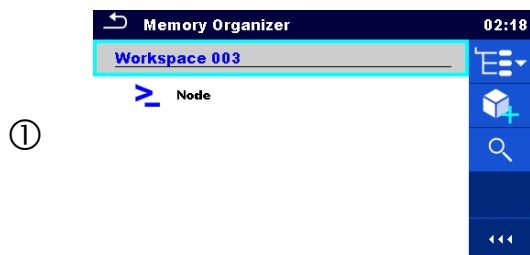


New Workspace is selected and displayed on the screen.

5.1.4 Adding Nodes in Memory Organizer

Structural Elements (Nodes) are used to ease organization of data in the Memory Organizer. One Node is a must; others are optional and can be created or deleted freely.

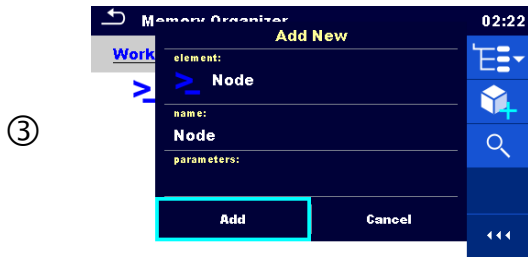
Procedure



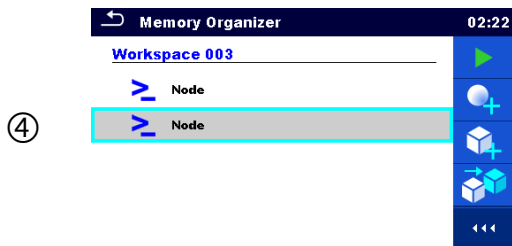
Press the active Workspace in Memory Organizer Menu.



Select Add New Structure Element in Control panel.



Change name of the Node if necessary and press Add to confirm.



New Structure Element (Node) will be added.

5.1.5 Operations in Tree Menu

In the Memory organizer different actions can be taken with help of the control panel at the right side of the display. Possible actions depend on the selected element in the organizer.

5.1.5.1 Operations on measurements (finished or empty measurements)

The measurement must be selected first. Operation options can be selected from the menu on the right side of the screen. Menu options are adopted to measurement status, empty, finished, finished and saved, as presented on *Figure 5.6*.

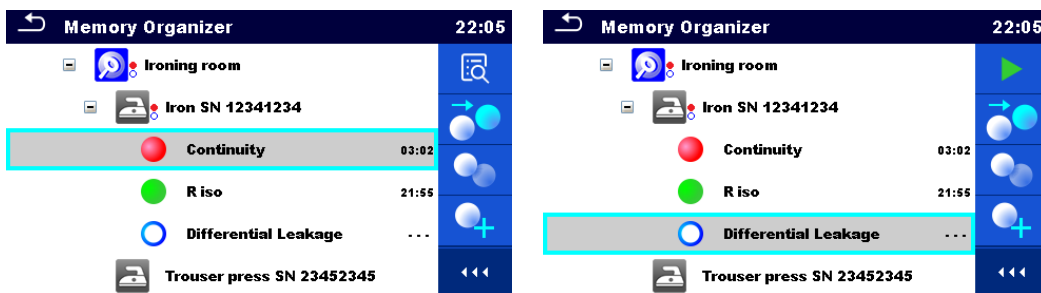





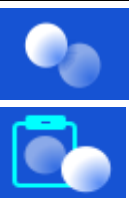



Figure 5.6: A measurement is selected in the tree menu

Options



Views results of measurement.

The instrument goes to the measurement memory screen. Refer to chapters 6.1.1.5 *Single test memory screen* and 7.2.4 *Auto Sequence® memory screen* for more information.

	<p>Starts a new measurement.</p> <p>The instrument goes to the measurement start screen. Refer to chapters 6.1.1.1 <i>Single test start screen</i> and 7.2.1 <i>Auto Sequence® view menu</i> for more information.</p>
	<p>Saves a measurement.</p> <p>Saving of measurement on a position after the selected (empty or finished) measurement.</p>
	<p>Clones the measurement.</p> <p>The selected measurement can be copied as an empty measurement under the same Structure object. Refer to <i>Chapter 5.1.5.7 Clone a measurement</i> for more information.</p>
	<p>Copies & Paste a measurement.</p> <p>The selected measurement can be copied and pasted as an empty measurement to any location in structure tree. Multiple "Paste" is allowed. Refer to <i>Chapter 5.1.5.9 Copy & Paste a measurement</i> for more information.</p>
	<p>Adds a new measurement.</p> <p>The instrument goes to the Menu for adding measurements. Refer to <i>Chapter 5.1.5.5 Add a new measurement</i> for more information.</p>
	<p>Views and edit comments.</p> <p>The instrument displays comment attached to the selected measurement or opens keypad for entering a new comment.</p>
	<p>Deletes a measurement.</p> <p>Selected Measurement can be deleted. User is asked for confirmation before the deleting. Refer to <i>Chapter 5.1.5.11 Delete a measurement</i> for more information.</p>

5.1.5.2 Operations on Structure objects

The structure object must be selected first.

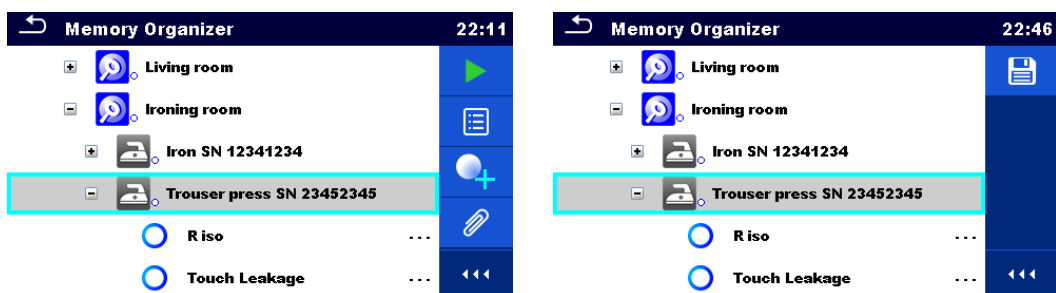



Figure 5.7: A structure object is selected in the tree menu

Options

	<p>Starts a new measurement.</p> <p>First type of measurement (single test or Auto sequence®) should be selected. After proper type is selected the instrument goes to single test or Auto</p>
---	--

Sequence® selection screen. Refer to *Chapters 6.1 Selection modes* and *7.1 Selection of Auto Sequences®* for more information.



Saves a measurement.

Saving of measurement under the selected Structure object.



View / edit parameters and attachments.

Parameters and attachments of the Structure object can be viewed or edited. Refer to Chapter *5.1.5.3 View / Edit parameters and attachments of a Structure object* for more information.



Adds a new measurement.

The instrument goes to the Menu for adding measurement into structure. Refer to Chapter *5.1.5.5 Add a new measurement* for more information.



Adds a new Structure object.

A new Structure object can be added. Refer to Chapter *5.1.5.4 Add a new Structure Object* for more information.



Attachments.

Name and link of attachment is displayed.



Clones a Structure object.

Selected Structure object can be copied to same level in structure tree (clone). Refer to Chapter *5.1.5.6 Clone a Structure object* for more information.



Copies & Paste a Structure object.

Selected Structure object can be copied and pasted to any allowed location in structure tree. Multiple "Paste" is allowed. Refer to Chapter *5.1.5.8 Copy & Paste a Structure object* for more information.



Views and edit comments.

The instrument displays comment attached to the selected Structure object or opens keypad for entering a new comment.



Deletes a Structure object.

Selected Structure object and sub-elements can be deleted. User is asked for confirmation before the deleting. Refer to Chapter *5.1.5.10 Delete a Structure object* for more information.



Renames a Structure object.

Selected Structure object can be renamed via keypad. Refer to Chapter *5.1.5.12 Rename a Structure object* for more information.

5.1.5.3 View / Edit parameters and attachments of a Structure object

The parameters and their content are displayed in this menu. To edit the selected parameter tap on it or press RUN key to enter menu for editing parameters.

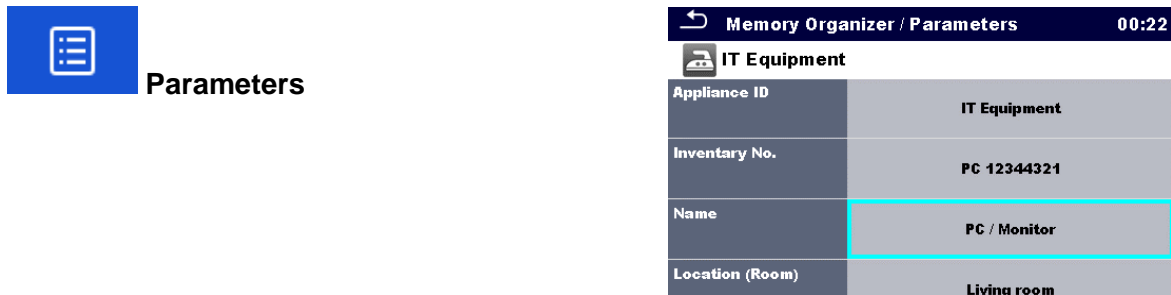
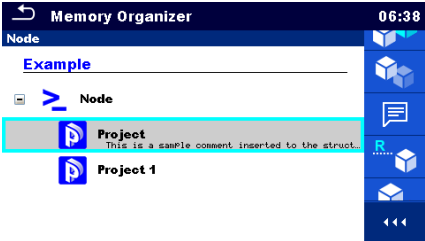

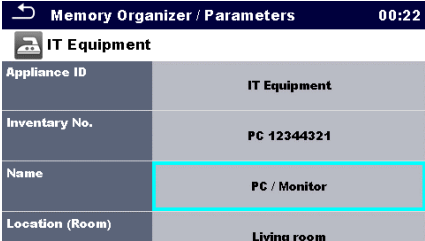
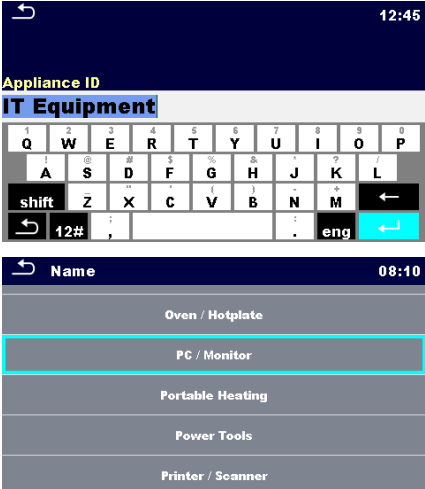


Figure 5.8: Example of View / Edit parameters menu

Procedure and options

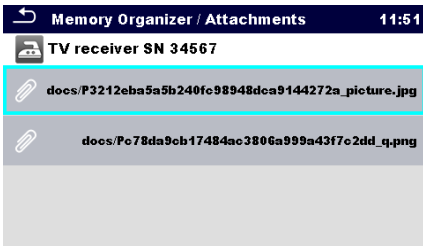
- ①  Select structure object to be edited.
- ②  Select Parameters in Control panel.
- ③  Example of Parameters menu.
- ④  In menu for editing parameters the parameter's value can be selected from a dropdown list or entered via keypad. Refer to chapter 4 *Instrument operation* for more information about keypad operation.

②a



Select Attachments in Control panel.

③a



Attachments

The name of attachment can be seen. Operation with attachments is not supported in the instrument.

②b



Select Comments in Control panel.

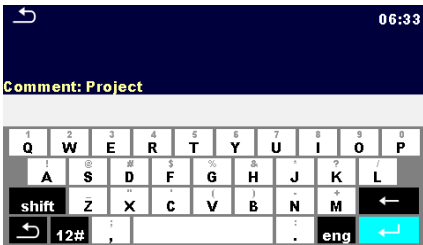
③b



View or edit comments

Complete comment (if exists) attached to the structure object can be seen on this screen.

Press RUN key or tap on screen to open keypad for entering a new comment.



5.1.5.4 Add a new Structure Object

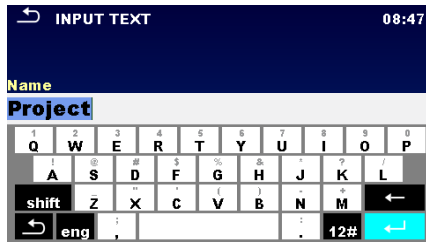
This menu is intended to add new structure objects in the tree menu. A new structure object can be selected and then added in the tree menu.



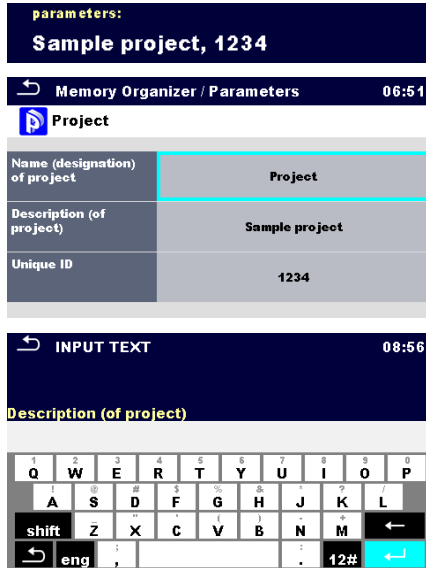
Figure 5.9: Add a new Structure Object menu

Procedure and options

- Default initial structure.
- Select Add Structure in Control panel.
- Add a new structure object menu.
- The type of structure object to be added can be selected first from dropdown menu.
Only structure objects that can be used in the same level or next sub-level are offered.
- The name of structure object can be edited.

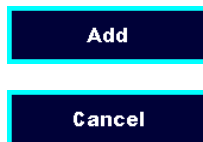


③c



Parameters of the Structure object can be edited.

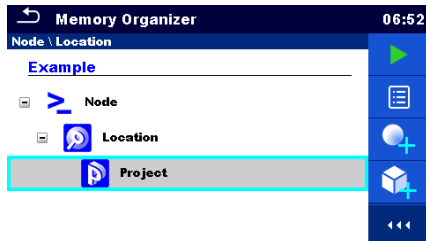
④



Adds the selected structure object in the tree menu.

Returns to the tree menu without changes.

⑤



New object added.

5.1.5.5 Add a new measurement

In this menu new empty measurements can be set and then added in the structure tree. The type of measurement, measurement function and its parameters are first selected and then added under the selected Structure object.

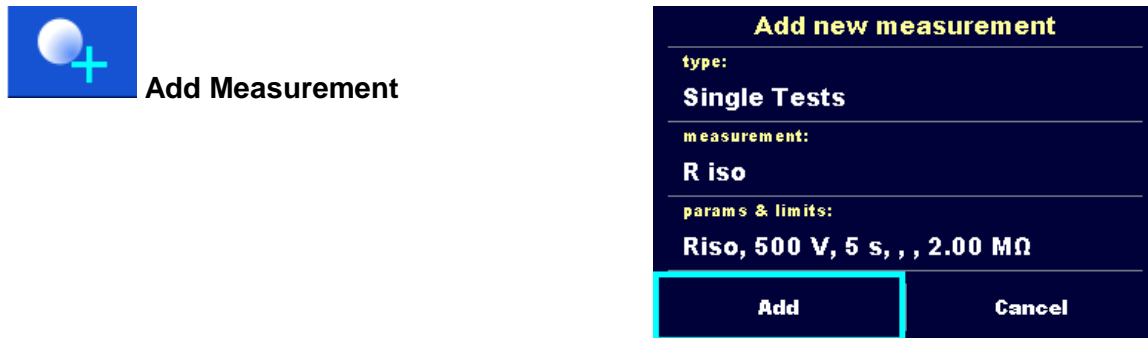
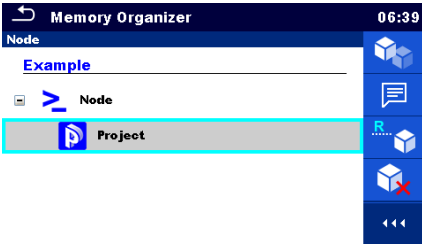

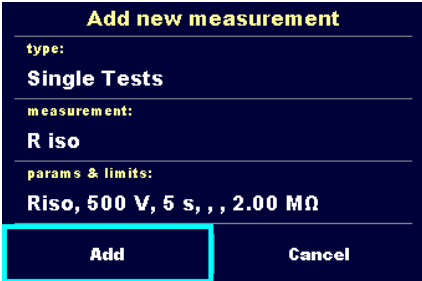

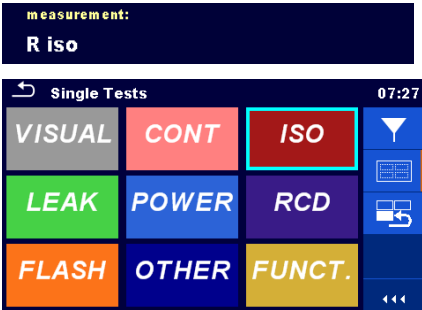
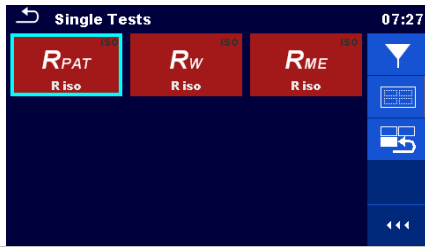


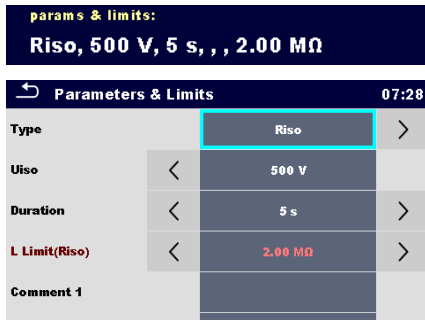
Figure 5.10: Add a new measurement menu

Procedure and options

- ①  Select level in structure where measurement will be added.
- ②  Select Add measurement in Control panel.
- ③  Add new measurement menu.
- ③a  Type of test can be selected from this field.
Options: (Single Tests, Auto Sequences®)
Tap on field or press the RUN key to modify.
- ③b  Last added measurement is offered by default.
To select another measurement tap on field or press the RUN to open menu for selecting measurements. Refer to *Chapters 6.1 Selection modes and 7.1 Selection of Auto Sequences* for more information.



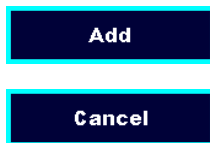
③c



Select parameter and modify it as described earlier.

Refer to *Chapter 6.1.1.2 Setting parameters and limits of single tests* for more information.

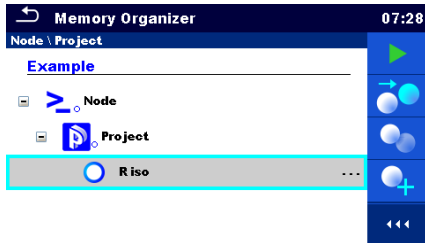
④



Adds the measurement under the selected Structure object in the tree menu.

Returns to the structure tree menu without changes.

⑤



New empty measurement is added under the selected Structure object.

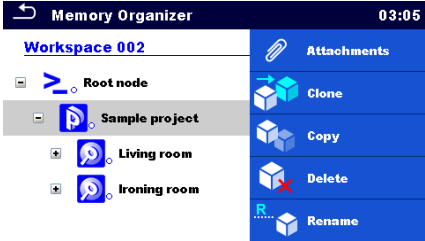

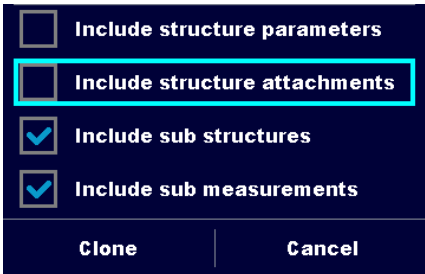


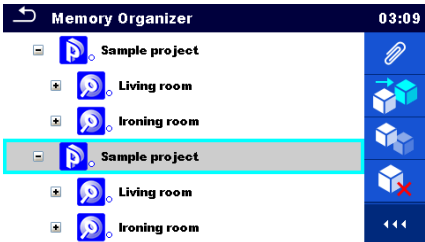
5.1.5.6 Clone a Structure object

In this menu selected structure object can be copied (cloned) to same level in the structure tree. Cloned structure object have same name as original.



Figure 5.11: Clone Structure Object menu

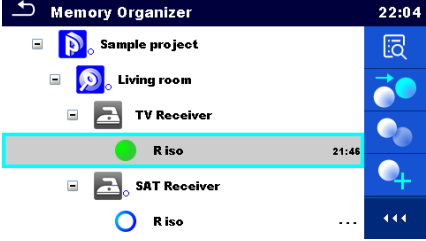

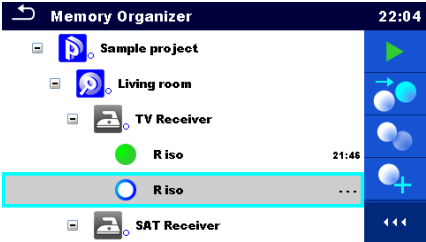
Procedure and options

- ①  Select the structure object to be cloned.
- ②  Select Clone option from control panel.
- ③  The Clone Structure object menu is displayed. Sub-elements of the selected structure object can be marked or un-marked for cloning. Refer to *Chapter 5.1.5.8 Copy & Paste a Structure object* for more information.
- ④a  Selected structure object is copied (cloned) to same level in the structure tree.
- ④b  Cloning is cancelled. No changes in the Structure tree.
- ⑤  The new structure object is displayed.

5.1.5.7 Clone a measurement

By using this function a selected empty or finished measurement can be copied (cloned) as an empty measurement to the same level in the structure tree.

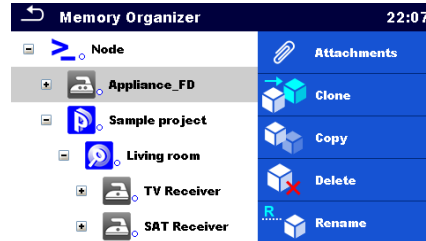


Procedure and options

- | | |
|--|--|
| <p>①</p>  | <p>Select the measurement to be cloned.</p> |
| <p>②</p>  <p>Clone</p> | <p>Select Clone option from control panel.</p> |
| <p>③</p>  | <p>The new empty measurement is displayed.</p> |

5.1.5.8 Copy & Paste a Structure object

In this menu selected Structure object can be copied and pasted to any allowed location in the structure tree.

Procedure and options

- | | |
|---|--|
| <p>①</p>  | <p>Select the structure object to be copied.</p> |
| <p>②</p>  <p>Copy</p> | <p>Select Copy option from control panel.</p> |
| <p>③</p>  | <p>Select location where structure element should be copied.</p> |

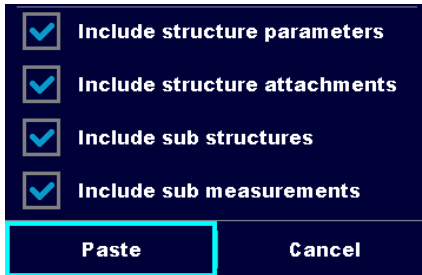
④



Paste

Select Paste option from control panel.

⑤



The Paste structure object menu is displayed. Before copying it can be set which sub-elements of the selected structure object will be copied too. For more details see options below.

⑥a



The selected structure object and elements are copied (pasted) to selected position in the tree structure.

⑥b



Returns to the tree menu without changes.

⑦



The new structure object is displayed.

Note:

The Paste command can be executed one or more times.

Options



Include structure parameters

Parameters of selected structure object will be copied too.



Include structure attachments

Attachments of selected structure object will be copied too.



Include sub structures

Structure objects in sub-levels of selected structure object will be copied too.



Include sub measurements

Measurements in selected structure object and sub-levels will be copied too.

5.1.5.9 Copy & Paste a measurement

In this menu selected measurement can be copied to any allowed location in the structure tree.

Procedure



Select the measurement to be copied.



Select Copy option from control panel.



Select location where measurement should be pasted.



Select Paste option from control panel.



The new (empty) measurement is displayed in selected Structure object.


Note:


The Paste command can be executed one or more times.

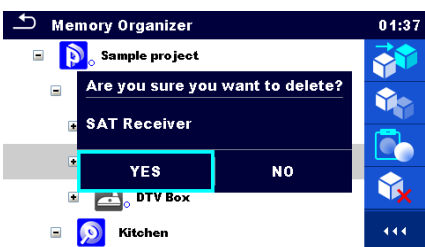
5.1.5.10 Delete a Structure object


In this menu selected Structure object can be deleted.

Procedure

①		Select the structure object to be deleted.
---	---	--

②		Select Delete option from control panel.
---	---	--

③		A confirmation window will appear.
---	--	------------------------------------


④a		Selected structure object and its sub-elements are deleted.
----	---	---

④b		Returns to the tree menu without changes.
----	---	---

5.1.5.11 Delete a measurement

In this menu selected measurement can be deleted.

Procedure

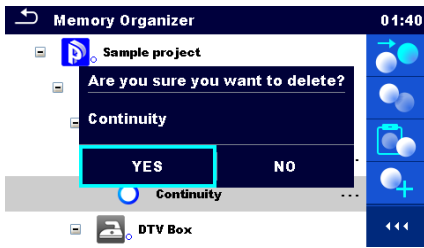
①		Select a measurement to be deleted.
---	---	-------------------------------------

②



Select Delete option from control panel.

③



A confirmation window will appear.

④a



Selected measurement is deleted.

④b



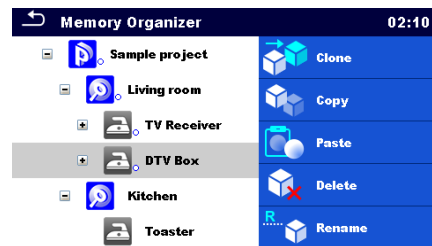
Returns to the tree menu without changes.

5.1.5.12 Rename a Structure object

In this menu selected Structure object can be renamed.

Procedure

①



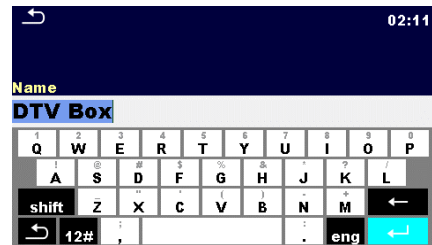
Select the structure object to be renamed.

②



Select Rename option from control panel.

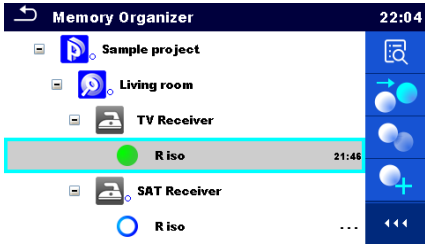

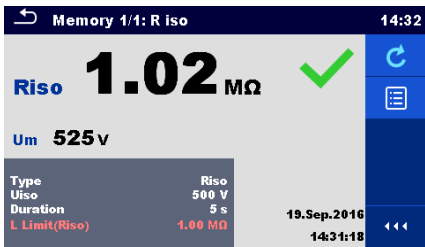

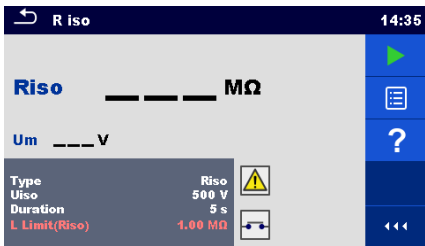
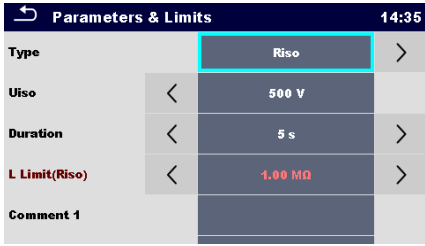

③

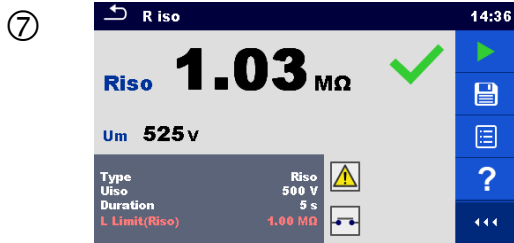


Virtual keypad will appear on screen. Enter new text and confirm.

5.1.5.13 Recall and Retest selected measurement

Procedure

- ①  Select the measurement to be recalled.
- ②  **Recall results** Select Recall results in control panel.
- ③  Measurement is recalled.
Parameters and limits can be viewed but cannot be edited.
- ④  **Retest** Select Retest in control panel.
- ⑤  Measurement retest starting screen is displayed.
- ⑤ a  Parameters and limits can be viewed and edited.
- ⑥  **Start Test** Select Run in control panel to retest the measurement.



Results / sub-results after re-run of recalled measurement.



Select Save results in control panel.



Retested measurement is saved under same structure item as original one.

Refreshed memory structure with the new performed measurement is displayed.

5.1.6 Searching in Memory Organizer

In Memory organizer it is possible to search for different structure objects and parameters.

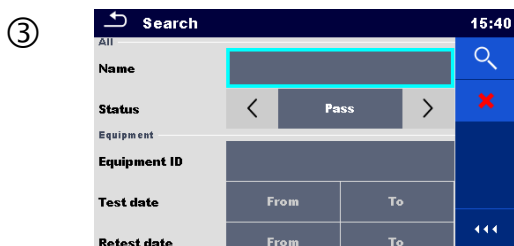
Procedure



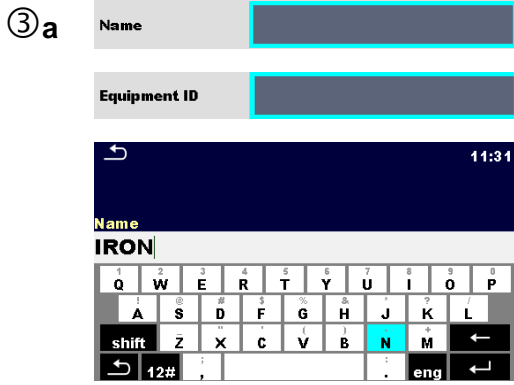
Search function is available from the active workspace directory line.



Select Search in control panel to open Search setup menu.



The parameters that can be searched for are displayed in the Search setup menu. Name and status are referred to all structure objects. If searching by status, instrument will display all structure objects that include one or more measurements with searched status. Equipment ID, Test date, Retest date refer only to the following structure objects: Appliance, Appliance FD, Medical equipment, Medical equipment FD, Welding equipment and Welding equipment FD.

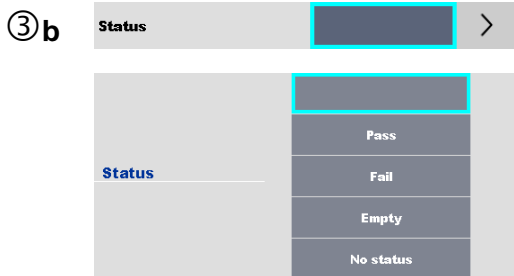


The search can be narrowed by entering a text in the Name and Equipment ID fields.

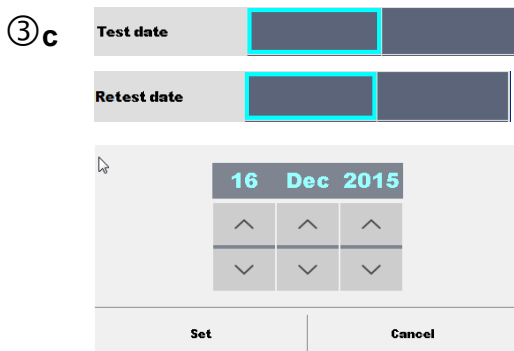
Strings can be entered using the on-screen keyboard.

Note:

The Search function on Equipment ID is case sensitive.



The search can be narrowed on base of statuses.



The search can be narrowed on base of test dates / retest dates (from / to).



Clears all filters. Sets filters to default value.



Searches through the Memory Organizer for objects according to the set filters. The results are shown in the Search results screen presented on *Figure 5.12* and *Figure 5.13*.

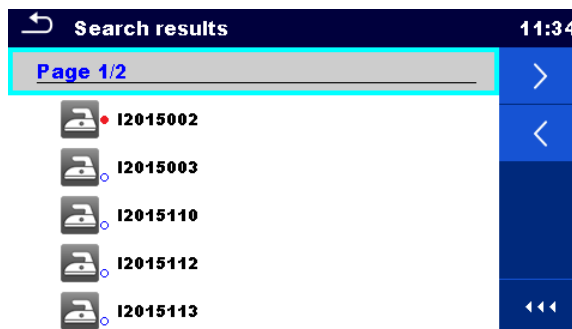


Figure 5.12: Search results screen – Page view

Options



Next page.



Previous page.

Note:

Search result page consist of up to 50 results.

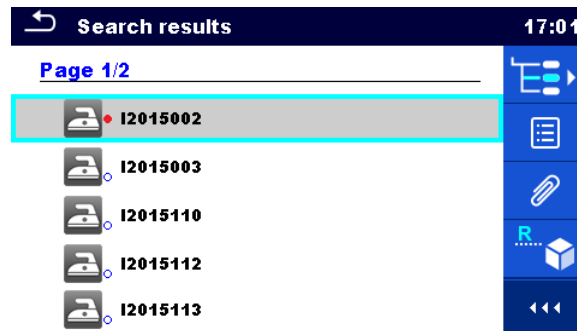


Figure 5.13: Search results screen with structure object selected

Options



Goes to location in Memory Organizer.



View / edit parameters and attachments.
Parameters and attachments of the Structure object can be viewed or edited. Refer to [Chapter 5.1.5.3 View / Edit parameters and attachments of a Structure object](#) for more information.



Attachments.
Name and link of attachment is displayed.



Views comment.
The instrument displays comment attached to the selected Structure object.



Renames the selected Structure object.
Refer to [Chapter 5.1.5.12 Rename a Structure object](#) for more information.

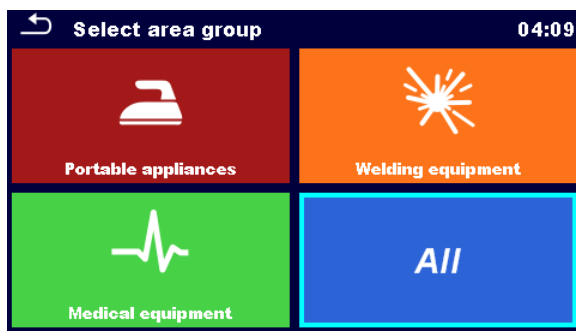
6 Single tests

Single tests can be selected in the Main single test menu or in Memory Organizer’s main and submenus.

6.1 Selection modes

In Single tests main menu Area group and two different modes for selecting single tests are available.

Options

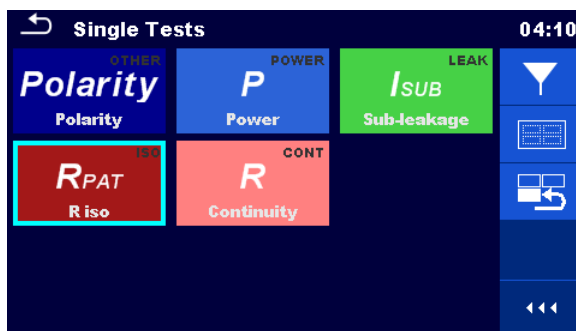


Area Group

With help of area groups it is possible to limit the offered single tests. The instrument has three area groups:

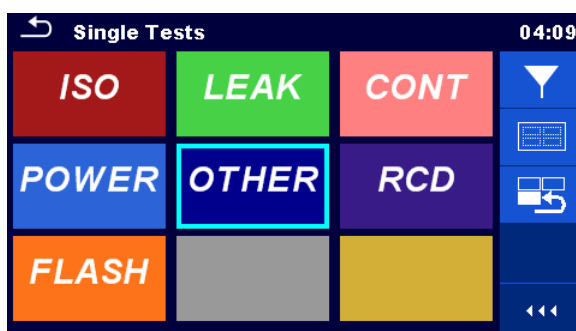
- › *Portable appliances*
- › *Medical equipment*
- › *Welding equipment*

Group *All* combine all single tests.



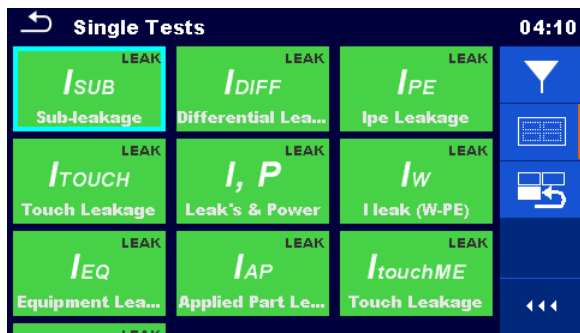
Last used

Up to last 9 different executed single tests within selected Area group are displayed.



Groups

The single tests are divided into groups of similar tests within selected Area group.



For the selected group a submenu with all single tests that belongs to the selected group and Area group is displayed.

6.1.1 Single test screens

In the Single test screens measuring results, sub-results, limits and parameters of the measurement are displayed. In addition on-line statuses, warnings and other information are displayed.

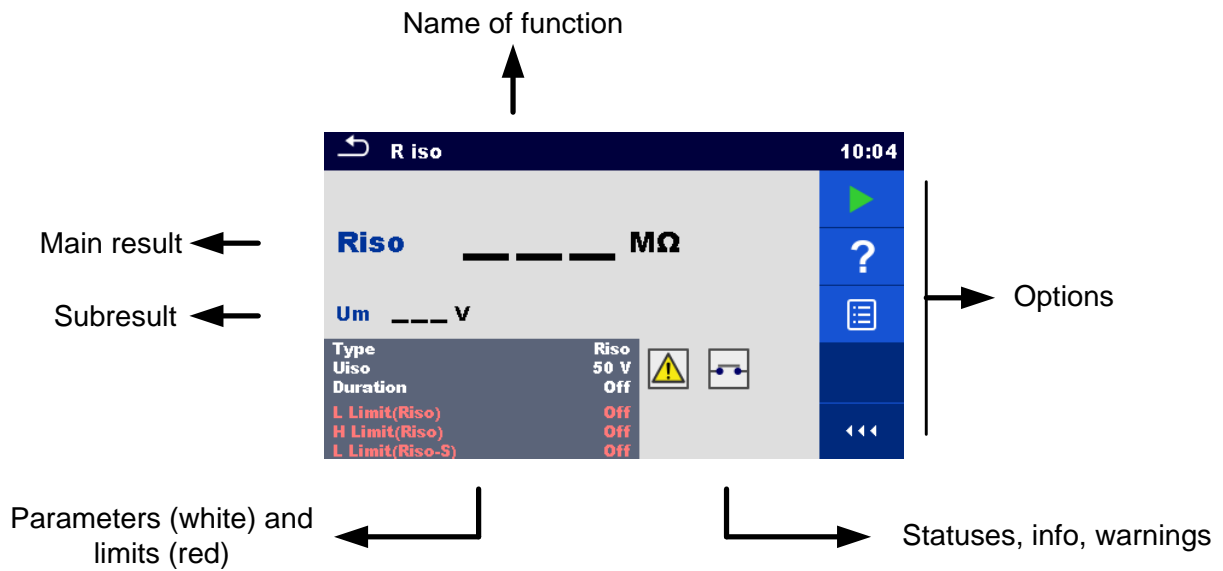


Figure 6.1: Single test screen organisation

6.1.1.1 Single test start screen

Single test start screen can be opened from Memory organizer or from Single test main menu.

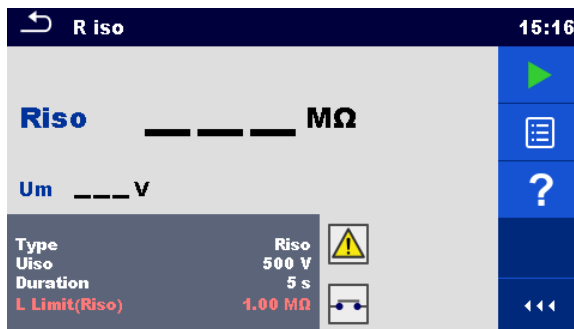


Figure 6.2: Single test start screen

Options



Starts the measurement.



Opens help screens. Refer to chapter 6.1.3 *Help screens* for more information.



Opens menu for changing parameters and limits. Refer to chapter 6.1.1.2 *Setting parameters and limits of single tests* for more information.



on

6.1.1.2 Setting parameters and limits of single tests

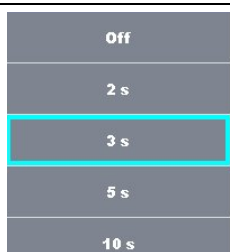


Figure 6.3: Screens in menu for setting Single test parameters and limits

Options



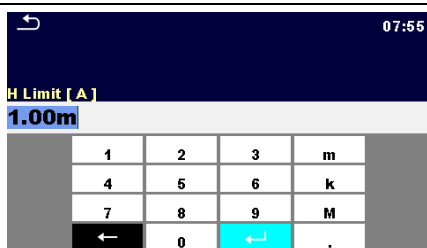
Selects parameter (white) or limit (red).



Selects value of parameter or limit.

In case of many (multiple pages of) parameters or limits:

- The scroll bar on the right side of screen can be used
- With right / left keys it can be jumped page up / page down



Enters custom value of parameter or limit.

Custom values can be entered by using the on-screen keyboard.

6.1.1.3 Single test screen during test

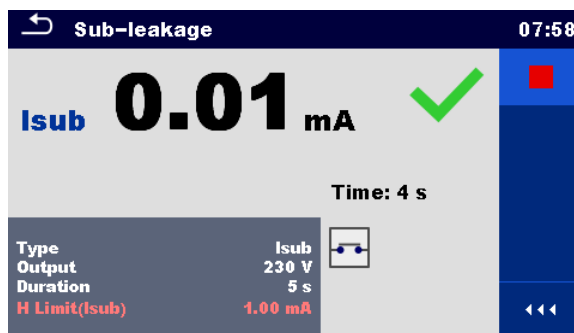
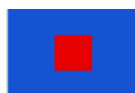


Figure 6.4: Single test screen (during measurement)

Options (during test)



Stops the single test measurement.



Proceeds to the next step of the measurement (if measurement consists of more steps).



Aborts measurement.



6.1.1.4 Single test result screen

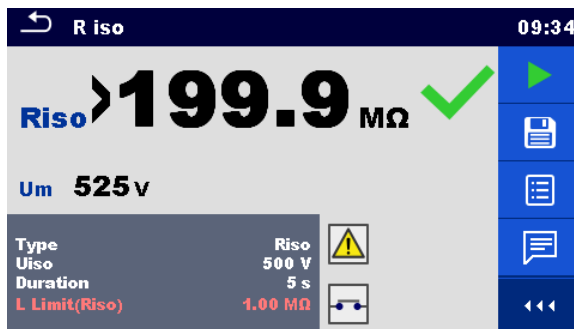


Figure 6.5: Single test result screen

Options (after measurement is finished)



Starts a new measurement.




Saves the result.

A new measurement was selected and started from a Structure object in the structure tree:

- The measurement will be saved under the selected Structure object.

A new measurement was started from the Single test main menu:

- Saving under the last selected Structure object will be offered by default. The user can select another Structure object or create a new Structure

object. By pressing the  key in Memory organizer menu the measurement is saved under selected location.

An empty measurement was selected from structure tree and started:

- The result(s) will be added to the measurement. The measurement will change its status from 'empty' to 'finished'.

An already carried out measurement was selected from structure tree, viewed and then restarted:

- A new measurement will be saved under the selected Structure object.



Adds comment to the measurement. The instrument opens keypad for entering a comment.



Opens help screens. Refer to chapter 6.1.3 *Help screens* for more information.



Opens screen for changing parameters and limits.

Refer to chapter 6.1.1.2 *Setting parameters and limits of single tests* for more information.



on

Type	Riso
Uiso	500 V
Duration	5 s
L Limit(Riso)	1.00 MΩ



Enters cross selector. Refer to chapter 6.1 *Selection modes* for more information.



long on

Riso	>199.9 MΩ
Um	525 v

6.1.1.5 Single test memory screen

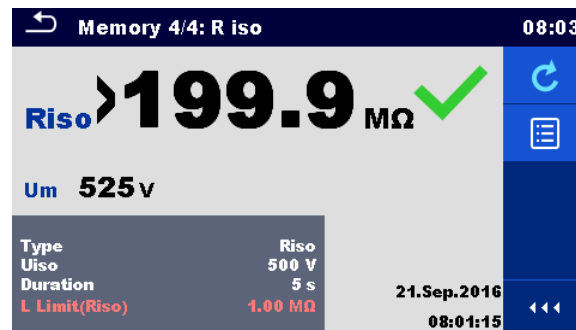


Figure 6.6: Single test memory screen

Options



Opens menu for viewing parameters and limits.

Refer to chapter 6.1.1.2 *Setting parameters and limits of single tests* for more information.



on

Type	Riso
Uiso	500 V
Duration	5 s
L Limit(Riso)	1.00 MΩ



Retest

Enters screen with “empty” measurement.



6.1.2 Single test (inspection) screens

Visual and Functional inspections can be treated as a special class of tests. Items to be visually or functionally checked are displayed. In addition on-line statuses and other information are displayed.

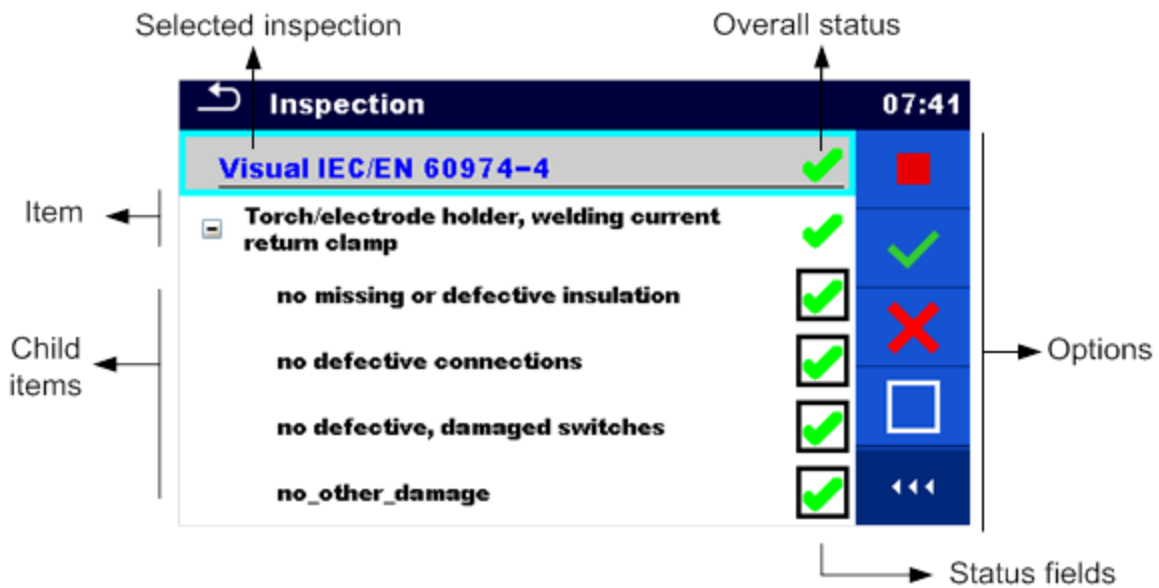


Figure 6.7: Inspection screen organisation

6.1.2.1 Single test (inspection) start screen

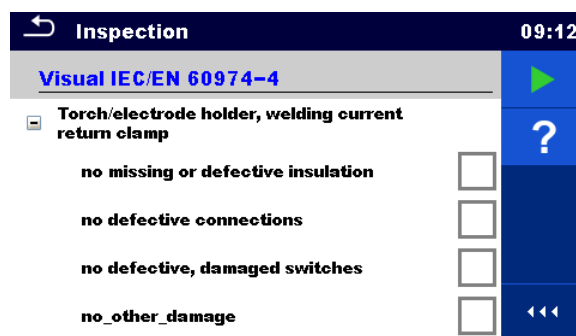


Figure 6.8: Inspection start screen

Options (inspection screen was opened in Memory organizer or from Single test main menu)



Starts the inspection.





Opens help screens. Refer to chapter 6.1.3 *Help screens* for more information.

6.1.2.2 Single test (Inspection) screen during test

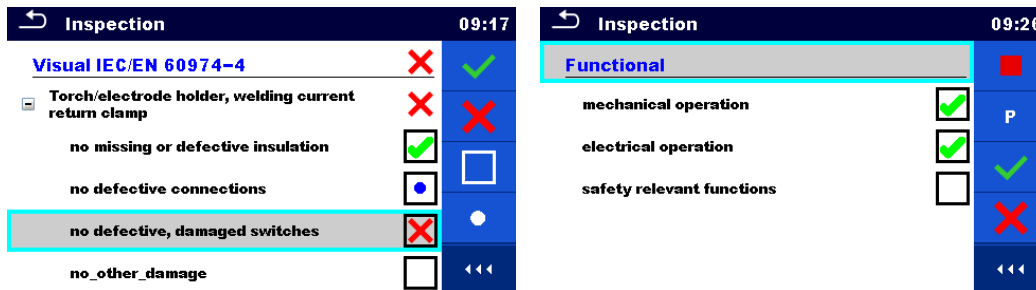


Figure 6.9: Inspection screen (during inspection)

Options (during test)

	Selects item.
	Applies a pass to the selected item or group of items.
	Applies a fail to the selected item or group of items.
	Clears status in selected item or group of items.
	Applies a status that item or group of items was checked.
	A status can be applied. Multiple taps toggles between statuses.
	Toggle between statuses.
	Power is applied to the mains test socket to power up the tested equipment during a functional inspection. The instrument displays and starts the Power measurement, refer to <i>Chapter 6.2.9 Power</i> .
	Stops Power measurement. Stops the inspection.



Stops the inspection.
Goes to the result screen.



Rules for automatic applying of statuses:

- › The parent item(s) can automatically get a status on base of statuses in child items.
 - the fail status has highest priority. A fail status for any item will result in a fail status in all parent items and an overall fail result.
 - if there is no fail status in child items the parent item will get a status only if all child items have a status.
 - Pass status has priority over checked status.
- › The child item(s) will automatically get a status on base of status in the parent item
 - All child items will get the same status as applied to the parent item.

Note

- › Inspections and even inspection items inside one inspection can have different status types. For example some basic inspections don't have the 'checked' status.
- › Only inspections with overall statuses can be saved.

6.1.2.3 Single test (Inspection) result screen

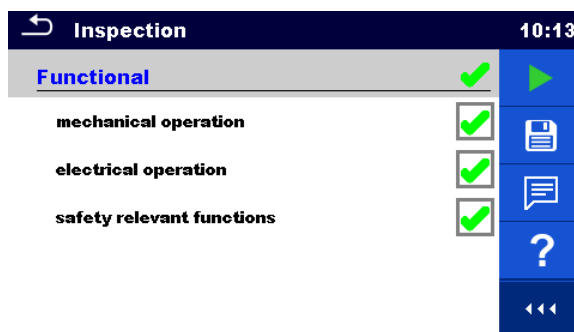


Figure 6.10: Inspection result screen

Options (after inspection is finished)



Starts a new inspection.




Saves the result.

A new inspection was selected and started from a Structure object in the structure tree:

- The inspection will be saved under the selected Structure object.

A new inspection was started from the Single test main menu:

- Saving under the last selected Structure object will be offered by default. The user can select another Structure object or create a

new Structure object. By pressing the  key in Memory organizer menu the inspection is saved under selected location.

An empty inspection was selected in structure tree and started:

- The result(s) will be added to the inspection. The inspection will change its status from 'empty' to 'finished'.

An already carried out inspection was selected in structure tree, viewed and then restarted:

- A new measurement will be saved under the selected Structure object.



Adds comment to the measurement. The instrument opens keypad for entering a comment.



Opens help screens. Refer to chapter 6.1.3 *Help screens* for more information.

6.1.2.4 Single test (inspection) memory screen

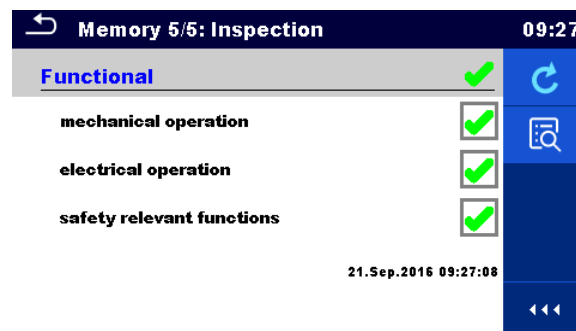


Figure 6.11: Inspection memory screen

Options



Retest

Starts inspection with cleared statuses.



Enters view mode.

6.1.3 Help screens

Help screens contain diagrams for proper connection of the instrument.

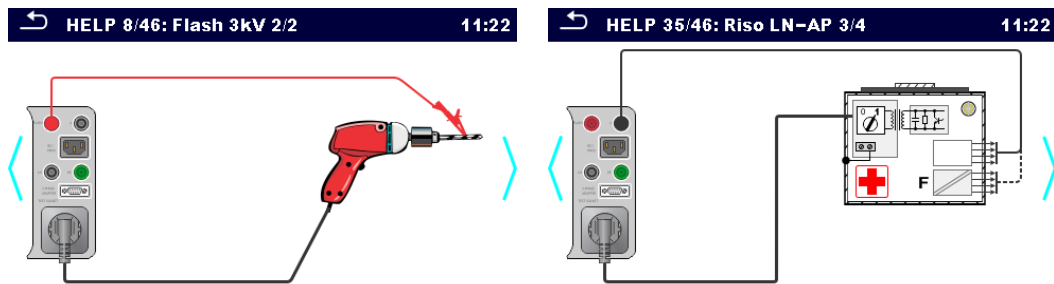


Figure 6.12: Examples of help screens

Options:



Opens help screen.



Goes to previous / next help screen.

6.2 Single test measurements

6.2.1 Visual inspection

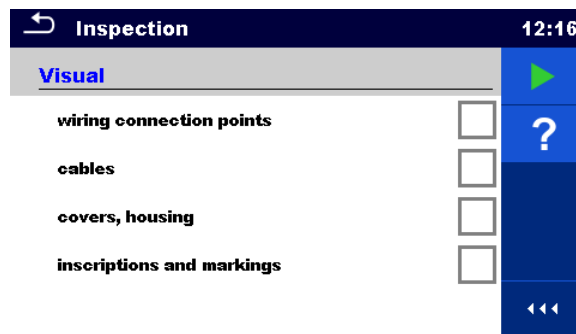


Figure 6.13: Visual inspection menu

Test circuit

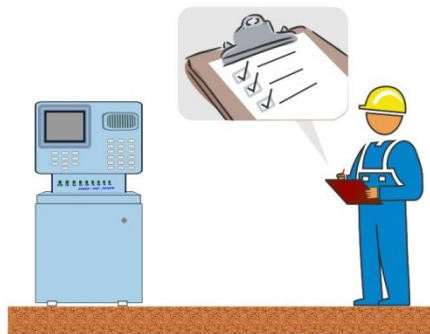


Figure 6.14: Visual inspection test circuit

Visual inspection procedure

- › Select the appropriate **Visual** function.
- › Start the inspection.
- › Perform the visual inspection of the appliance / equipment.
- › Apply appropriate ticker(s) to items of inspection.
- › End inspection.
- › Save results (optional).

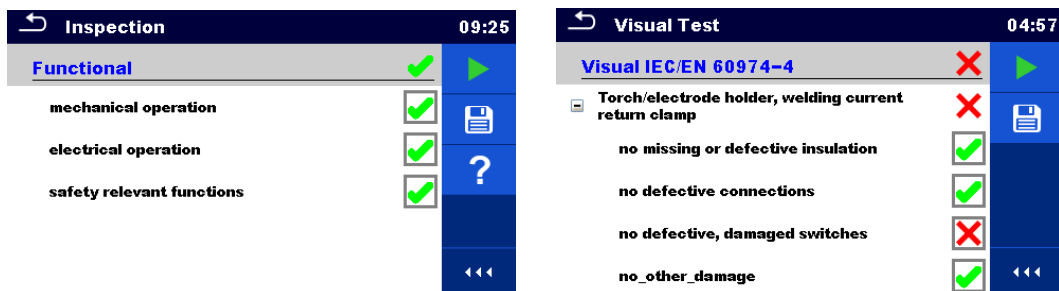


Figure 6.15: Examples of Visual inspection results

6.2.2 Continuity // Protective earth resistance



Figure 6.16: Continuity test // Protective earth resistance menu

Test results / sub-results

R.....Resistance

Test parameters

Output (Continuity)	Output: [P/S – PE, MS_PE – IEC_PE]
Output (Protective earth resistance)	Output: [P/S – PE]
Test current	I out: [0.2 A, 10 A, 25 A]
Duration	Duration: [Off, 2 s ... 180 s]

Test limits

Limit (R) (Continuity)	H Limit(R): [Off, 0.01 Ω ... 9 Ω, Custom]
Limit (R) (Protective earth resistance)	Limit(R): [Off, 0.1 Ω ... 0.5 Ω]

Test circuits

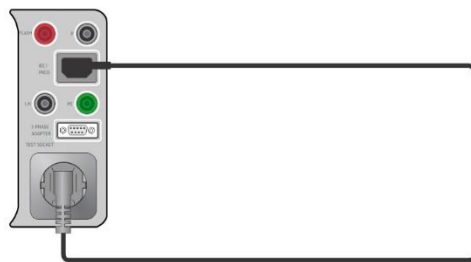


Figure 6.17: Continuity MS PE – IEC PE

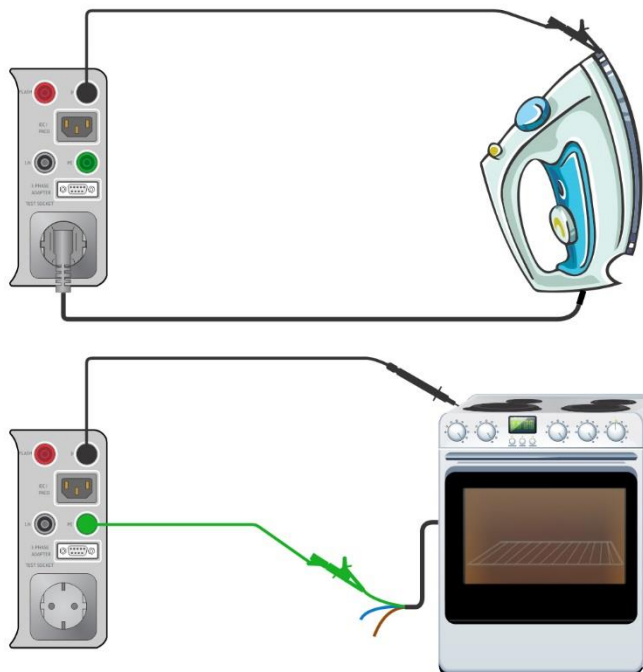


Figure 6.18: Continuity P/S – PE

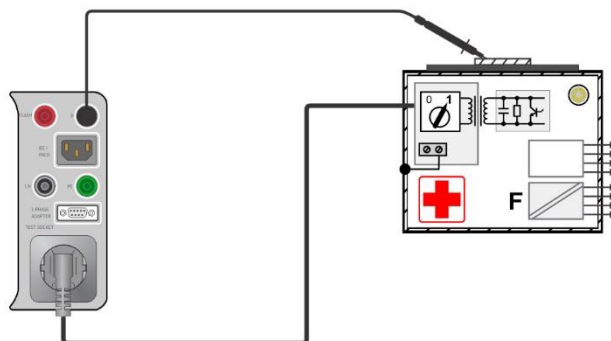


Figure 6.19: Protective Earth Resistance

Continuity // Protective earth resistance measurement procedure

- › Select the **Continuity // Protective Earth Resistance** function.
- › Set test parameters / limits.
- › Connect device under test to the instrument (see test circuits above).
- › Start measurement.
- › Measurement can be stopped manually or by timer.
- › Save results (optional).

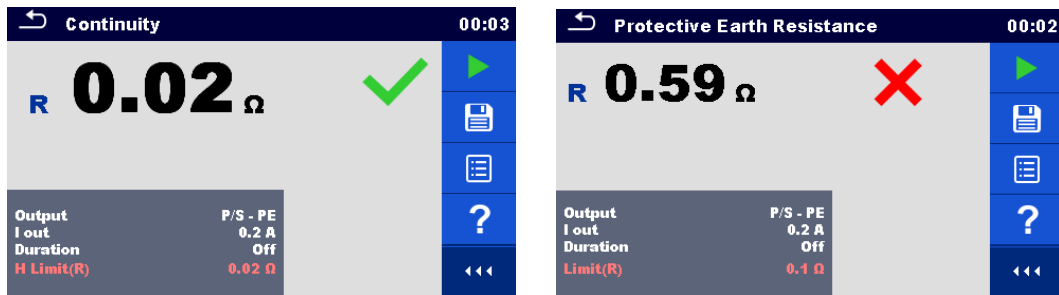


Figure 6.20: Example of Continuity and Protective Earth Resistance measurement results

6.2.2.1 Compensation of test lead / IEC test cable resistance

This chapter describes how to compensate the test leads resistance in **Continuity (Output = P/S – PE)** and **Protective Earth Resistance (Output = P/S – PE)** functions, and how to compensate IEC test cable resistance in **Continuity (Output = MS_PE – IEC_PE)** and **PE conductor (PRCD)** functions. Compensation can be carried out to eliminate the influence of test lead / IEC test cable resistance and the internal resistances of the instrument and adapters on the measured resistance.

Connection for compensating the resistance of test lead / IEC test cable

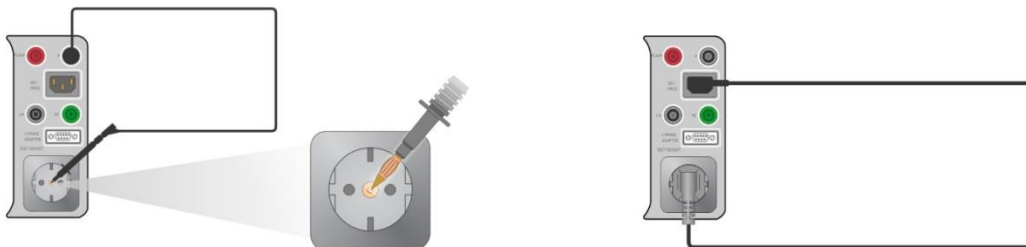


Figure 6.21: Shorted test lead / IEC test cable

Compensation of test lead / IEC test cable resistance procedure



- › Select the **Continuity // Protective Earth Resistance** function.
- › Set parameters (Output, Test current).
- › Connect test lead to the instrument between P/S terminal and PE terminal on test socket or connect IEC test cable between IEC connector and test socket, depending on settings, see *Figure 6.21*.
- › Touch the  key to compensate test lead / IEC test cable resistance.
- › Symbol  is displayed if the compensation was carried out successfully.



Figure 6.22: Result with old and new calibration values

Note:

- The calibration value is correct only for the output (P/S terminal – PE terminal on test socket) at which the calibration was carried out.

6.2.3 Flash test

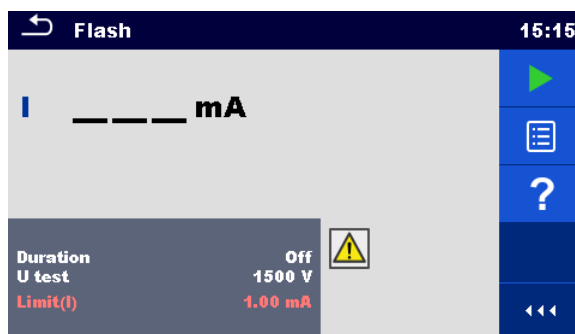


Figure 6.23: Flash test menu

Test results / sub-results

Imeasured a.c. test current

Test parameters

Output test voltage	U test: [1500 V, 3000 V]
Duration	Duration: [Off, 2 s ... 180 s]

Test limits

Limit (I)	Limit(I): [0.50 mA ... 2.25 mA]
-----------	----------------------------------

Test circuits

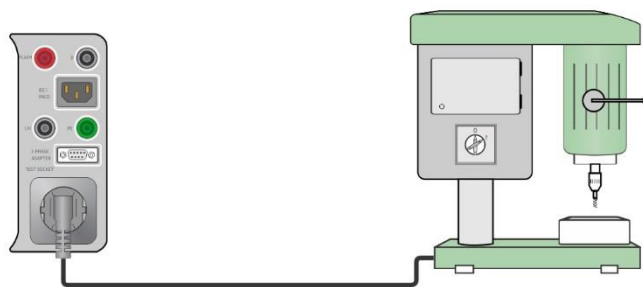


Figure 6.24: Flash test 1500 V

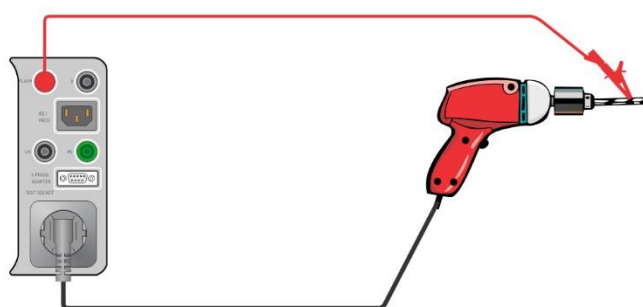


Figure 6.25: Flash test 3000 V

Flash measurement procedure

- › Select the **Flash** function.
- › Set test parameters / limits.
- › Connect device under test to the instrument (see test circuits above).
- › Start measurement.
- › Measurement can be stopped manually or by timer.
- › Save results (optional).

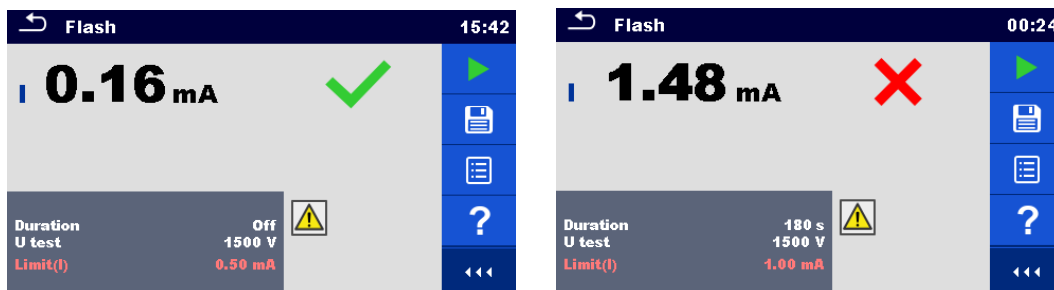


Figure 6.26: Examples of Flash measurement results

6.2.4 Insulation resistance (Riso, Riso-S)

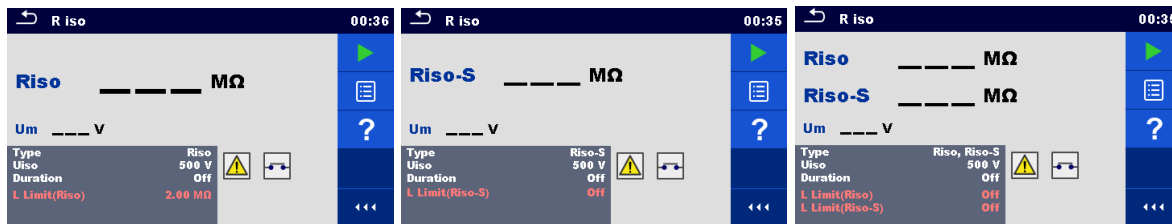


Figure 6.27: Insulation resistance test menus

Test results / sub-results

RisoInsulation resistance
 Riso-SInsulation resistance-S
 Um.....Test voltage

Test parameters

Type of test	Type [Riso, Riso-S, (Riso, Riso-S)]
Nominal test voltage	Uiso [250 V, 500 V]
Duration	Duration [Off, 2 s ... 180 s]

Test limits

Limit (Riso)	L Limit(Riso) [Off, 0.01 MΩ ... 10.0 MΩ]
Limit (Riso-S)	L Limit(Riso-S) [Off, 0.10 MΩ ... 10.0 MΩ]

Test circuits



Figure 6.28: Insulation resistance Riso (socket)

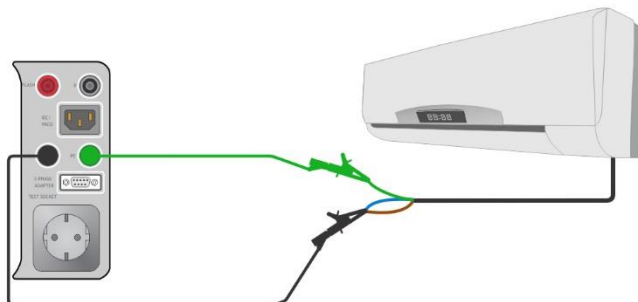


Figure 6.29: Insulation resistance Riso (LN – PE)

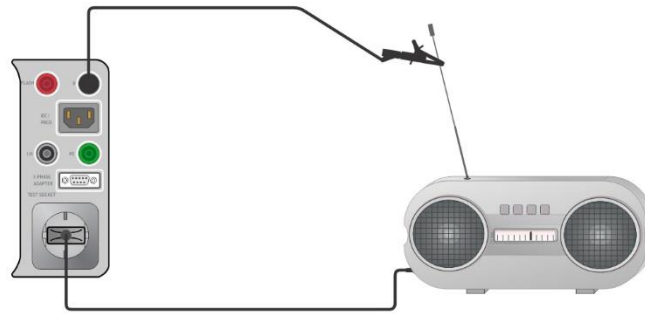


Figure 6.30: Insulation resistance measurement with probe Riso-S (socket – P/S)

Insulation resistance measurement procedure

- › Select the **R iso** function.
- › Set test parameters / limits.
- › Connect device under test to the instrument (see test circuits above).
- › Start measurement.
- › Measurement can be stopped manually or by timer.
- › Save results (optional).

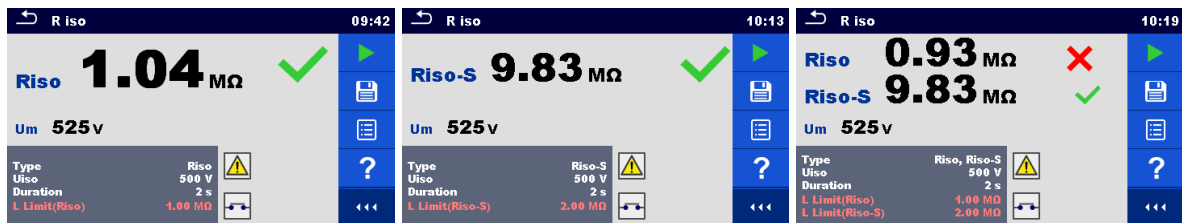


Figure 6.31: Examples of Insulation resistance measurement results

Note:

- › The current through the P/S probe is also considered in the Riso result.

6.2.5 Sub-leakage (Isub, Isub-S)

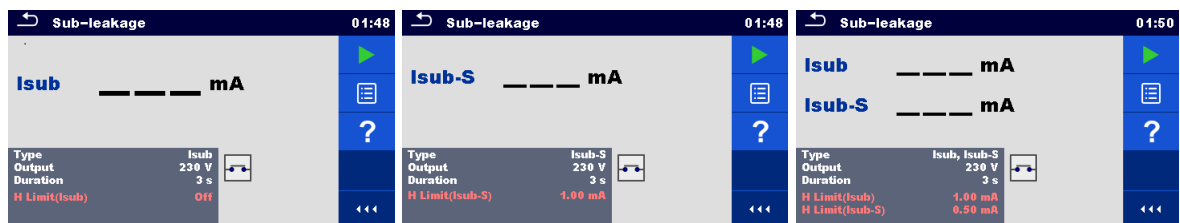


Figure 6.32: Sub Leakage test menus

Test results / sub-results

IsubSub-leakage current
 Isub-S.....Sub-leakage current-S

Test parameters

Type of test	Type [Isub, Isub-S, (Isub, Isub-S)]
Output voltage	Output [230 V]ac
Duration	Duration [Off, 2 s ... 180 s]

Test limits

Limit (Isub)	H Limit(Isub) [Off, 0.25 mA ... 15.0 mA, Custom]
Limit (Isub-S)	H Limit(Isub-S) [Off, 0.25 mA ... 15.0 mA]

Test circuits



Figure 6.33: Sub-leakage Isub (socket)

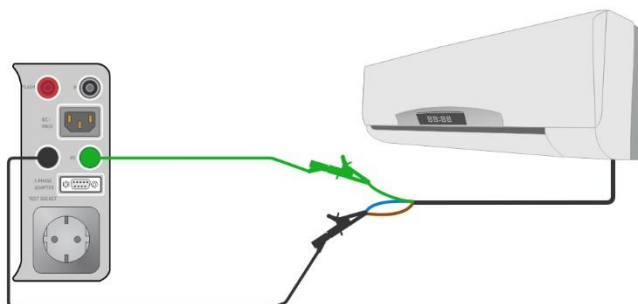


Figure 6.34: Sub-leakage Isub (LN – PE)

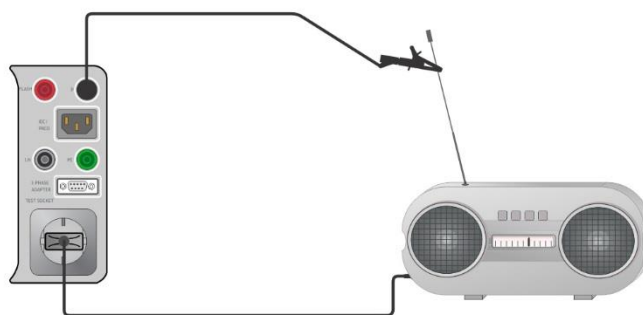


Figure 6.35: Sub-leakage measurement with probe Isub-S (socket – P/S)

Sub-leakage measurement procedure

- › Select the **Sub-leakage** function.
- › Set test parameters / limits.
- › Connect device under test to the instrument (see test circuits above).
- › Start measurement.
- › Measurement can be stopped manually or by timer.
- › Save results (optional).

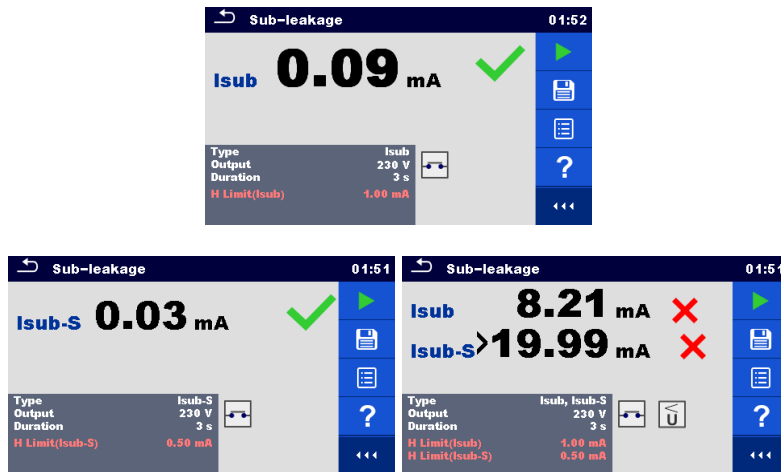


Figure 6.36: Examples of Sub-leakage measurement results

Note:

- › When P/S probe is connected during the Sub-leakage measurement, then the current through it is also considered.

6.2.6 Differential Leakage

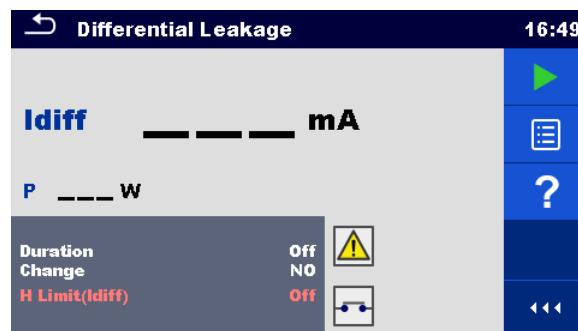


Figure 6.37: Differential Leakage test menu

Test results / sub-results

IdiffDifferential Leakage current
 PPower

Test parameters

Duration	Duration [Off, 2 s ... 180 s]
Change status	Change [YES, NO] YES: The instrument measures leakage current in two sequential steps with delay* in between. The phase voltage is firstly applied to the right live output of the mains test socket and secondly to the left live output of the mains test socket. NO: The phase voltage is applied only to the right live output of the mains test socket.
*Delay time	Delay [0.2 s ... 5 s]

Test limits

Limit (Idiff)	H limit [Off, 0.25 mA ... 15.0 mA, Custom]
---------------	--

Test circuit

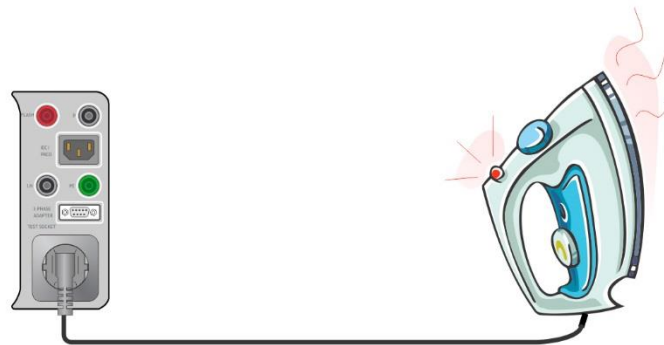


Figure 6.38: Differential leakage

Differential Leakage measurement procedure

- › Select the **Differential Leakage** function.
- › Set test parameters / limits.
- › Connect device under test to the instrument (see test circuits above).
- › Start measurement.
- › Measurement can be stopped manually or by timer.
- › Save results (optional).

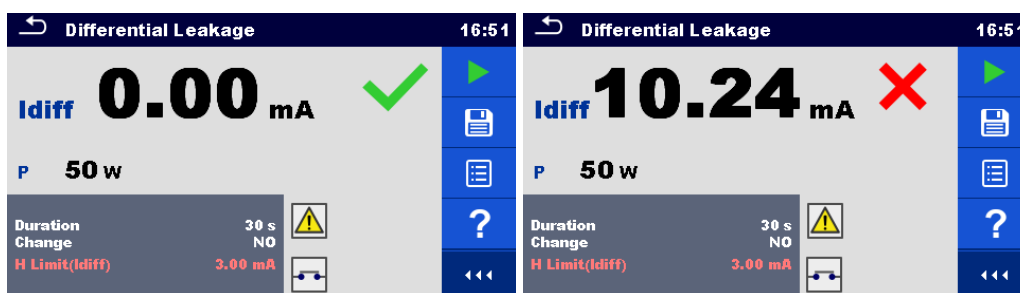


Figure 6.39: Examples of Differential Leakage measurement results

6.2.7 Ipe Leakage

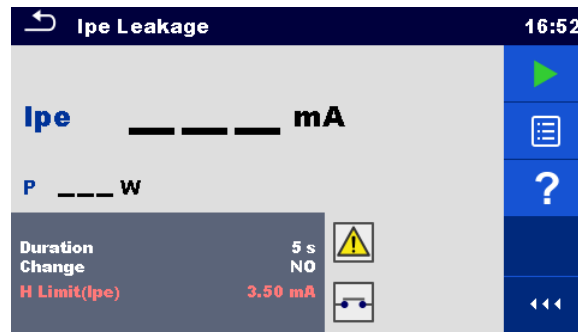


Figure 6.40: Ipe Leakage test menu

Test results / sub-results

IpePE current
 PPower

Test parameters

Duration	Duration [Off, 2 s ... 180 s]
Change status	Change [YES, NO] YES: The instrument measures leakage current in two sequential steps with delay* in between. The phase voltage is firstly applied to the right live output of the mains test socket and secondly to the left live output of the mains test socket. NO: The phase voltage is applied only to the right live output of the mains test socket.
*Delay time	Delay [0.2 s ... 5 s]

Test limits

Limit (Ipe)	H Limit(Ipe) [Off, 0.25 mA ... 15.0 mA, Custom]
-------------	---

Test circuit

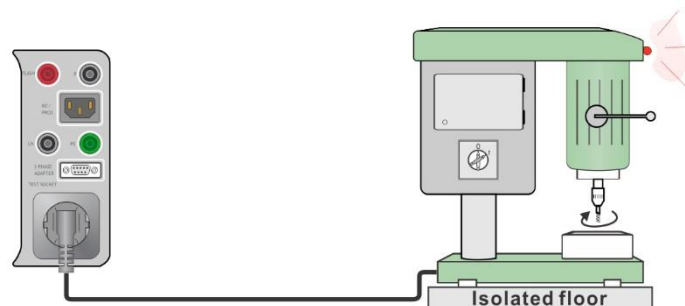


Figure 6.41: Ipe leakage

Ipe Leakage measurement procedure

- › Select the **Ipe Leakage** function.
- › Set test parameters / limits.
- › Connect device under test to the instrument (see test circuit above).
- › Start measurement.
- › Measurement can be stopped manually or by timer.

- Save results (optional).

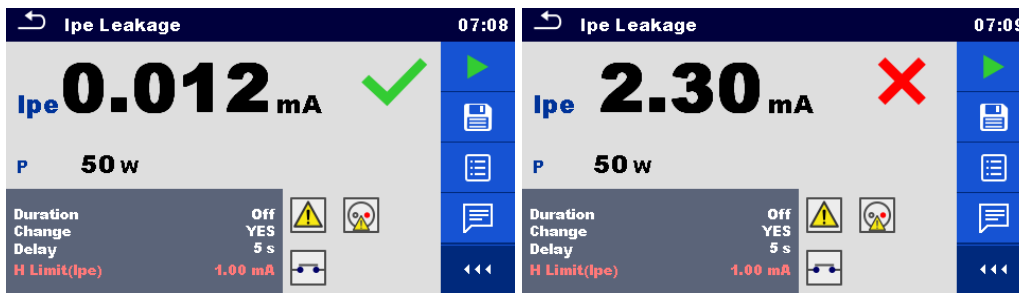


Figure 6.42: Examples of Ipe Leakage measurement results

6.2.8 Touch Leakage

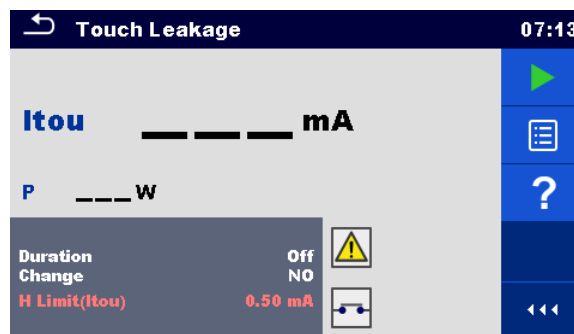


Figure 6.43: Touch Leakage test menu

Test results / sub-results

ItouTouch Leakage current
 P.....Power

Test parameters

Duration	Duration [Off, 2 s ... 180 s]
Change status	Change [YES, NO] YES: The instrument measures leakage current in two sequential steps with delay* in between. The phase voltage is firstly applied to the right live output of the mains test socket and secondly to the left live output of the mains test socket. NO: The phase voltage is applied only to the right live output of the mains test socket.
*Delay time	Delay [0.2 s ... 5 s]

Test limits

Limit (Itou)	H limit(Itou) [Off, 0.25 mA ... 15.0 mA]
--------------	--

Test circuit

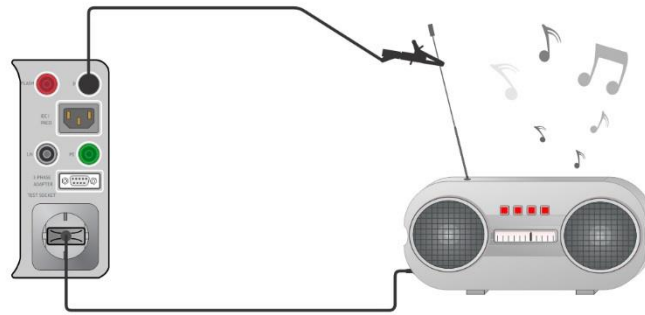


Figure 6.44: Touch Leakage

Touch Leakage measurement procedure

- › Select the **Touch Leakage** function.
- › Set test parameters / limits.
- › Connect device under test to the instrument (see test circuit above).
- › Start measurement.
- › Measurement can be stopped manually or by timer.
- › Save results (optional).

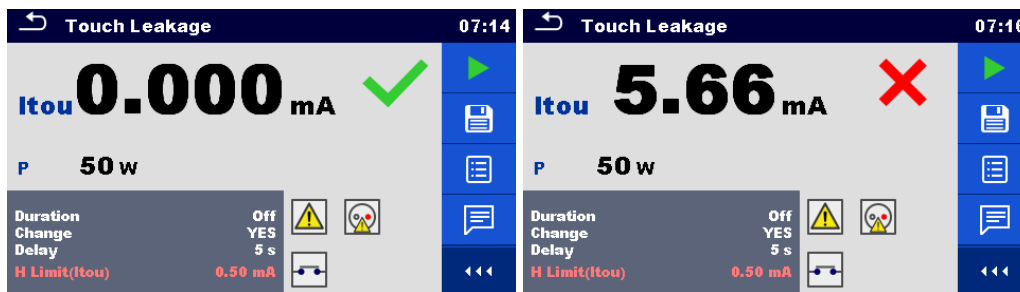


Figure 6.45: Examples of Touch Leakage measurement results

6.2.9 Power

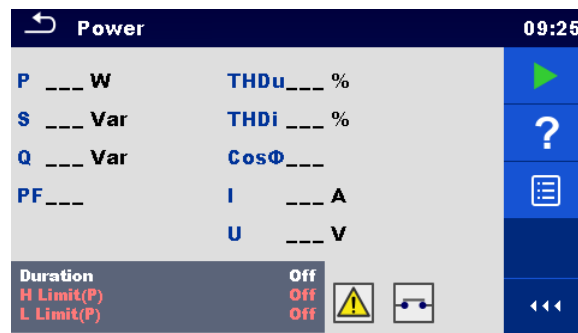


Figure 6.46: Power measurement menu

Test results / sub-results

- P.....Active power
- S.....Apparent power
- QReactive power
- PF.....Power factor
- THDu..... Total harmonic distortion – voltage
- THDi..... Total harmonic distortion – current
- Cos Φ.....cosinus Φ
- ILoad current
- U.....Voltage

Test parameters

Duration	Duration [Off, 2 s ... 180 s]
----------	-------------------------------

Test limits

High Limit (P)	H limit(P) [Off, 10 W ... 3.50 kW, Custom]
Low Limit (P)	L limit(P) [Off, 10 W ... 3.50 kW, Custom]

Test circuit



Figure 6.47: Power

Power measurement procedure

- › Select the **Power** function.
- › Set test parameters / limits.
- › Connect device under test to the instrument (see test circuit above).
- › Start measurement.
- › Measurement can be stopped manually or by timer.

- Save results (optional).

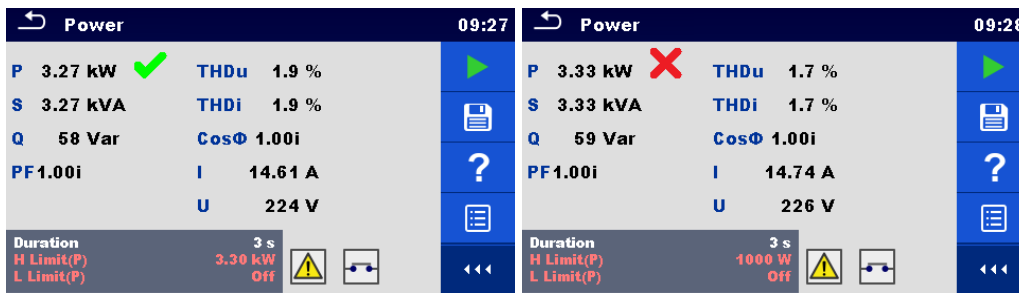


Figure 6.48: Examples of Power measurement results

6.2.10 Leak's & Power

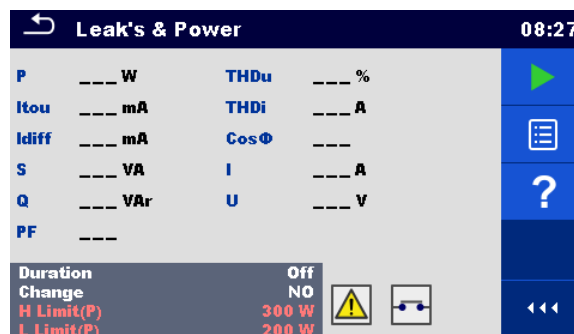


Figure 6.49: Leak's & Power measurement menu

Test results / sub-results

- P.....Active power
- ItouTouch Leakage current
- IdiffDifferential Leakage current
- S.....Apparent power
- QReactive power
- PF.....Power factor
- THDu.....Total harmonic distortion – voltage
- THDi.....Total harmonic distortion – current
- Cos Φ.....cosinus Φ
- ILoad current
- U.....Voltage

Test parameters

Duration	Duration [Off, 2 s ... 180 s]
Change status	Change [YES, NO] YES: The instrument measures leakage current in two sequential steps with delay* in between. The phase voltage is firstly applied to the right live output of the mains test socket and secondly to the left live output of the mains test socket. NO: The phase voltage is applied only to the right live output of the mains test socket.
*Delay time	Delay [0.2 s ... 5 s]

Test limits

High Limit (P)	H Limit(P) [Off, 10 W ... 3.50 kW, Custom]
Low Limit (P)	L Limit(P) [Off, 10 W ... 3.50 kW, Custom]
High Limit (Idiff)	H Limit(Idiff) [Off, 0.25 mA ... 15.0 mA, Custom]
High Limit (Itou)	H Limit(Itou) [Off, 0.25 mA ... 15.0 mA]

Test circuit



Figure 6.50: Leak's and Power

Leak's & Power measurement procedure

- Select the **Leak's & Power** function.
- Set test parameters / limits.
- Connect device under test to the instrument (see test circuit above).
- Start measurement.
- Measurement can be stopped manually or by timer.
- Save results (optional).



Figure 6.51: Examples of Leak's & Power measurement results

6.2.11 PRCD test

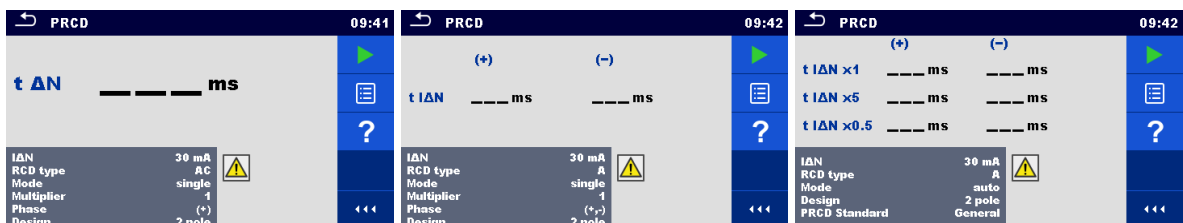


Figure 6.52: PRCD measurement menu

Test results / sub-results

- t ΔN trip out time
- t $I_{\Delta N} \times 1, (+)$ trip-out time ($I_{\Delta}=I_{\Delta N}, (+)$ positive polarity)
- t $I_{\Delta N} \times 1, (-)$ trip-out time ($I_{\Delta}=I_{\Delta N}, (-)$ negative polarity)
- t $I_{\Delta N} \times 5, (+)$ trip-out time ($I_{\Delta}=5 \times I_{\Delta N}, (+)$ positive polarity)
- t $I_{\Delta N} \times 5, (-)$ trip-out time ($I_{\Delta}=5 \times I_{\Delta N}, (-)$ negative polarity)
- t $I_{\Delta N} \times 0.5, (+)$ trip-out time ($I_{\Delta}=1/2 \times I_{\Delta N}, (+)$ positive polarity)
- t $I_{\Delta N} \times 0.5, (-)$ trip-out time ($I_{\Delta}=1/2 \times I_{\Delta N}, (-)$ negative polarity)
- I_dtrip out current
- I_d (+)trip-out current ((+) positive polarity)
- I_d (-)trip-out current ((-) negative polarity)

Test parameters

PRCD Type	Type [AC, A, B, B+, F]
Nominal current	$I_{\Delta N}$ [10 mA, 15 mA, 30 mA, 100 mA*, 300 mA*]
Test mode	Mode [single, auto]
Multiplication factor $I_{\Delta N}$	Multiplier [0.5, 1, 5]
Starting polarity in single mode	Phase [+ , - , (+,-)]
Design type	Design [2 pole, 3 pole, K/Di (varistor), S (3 pole)]
PRCD Standard	PRCD standard [General, AS/NZS 3017]

* in combination with 3 – phase adapters

Test limits

Test limits for Pass / Fail statuses are set automatically, depending on set parameters.

Test circuit



Figure 6.53: PRCD test

PRCD measurement procedure

- › Select the PRCD function.
- › Set test parameters / limits.
- › Connect the PRCD to the instrument (see test circuit above).
- › Start measurement.
- › Switch ON the PRCD within 5 s when prompted on the display.
- › Reactivate PRCD within 5 s when prompted on the display.
- › Save results (optional).

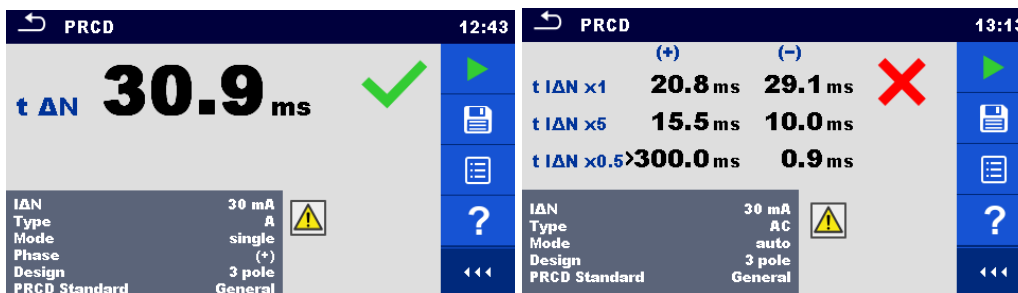


Figure 6.54: Examples of PRCD measurement results

6.2.12 RCD test

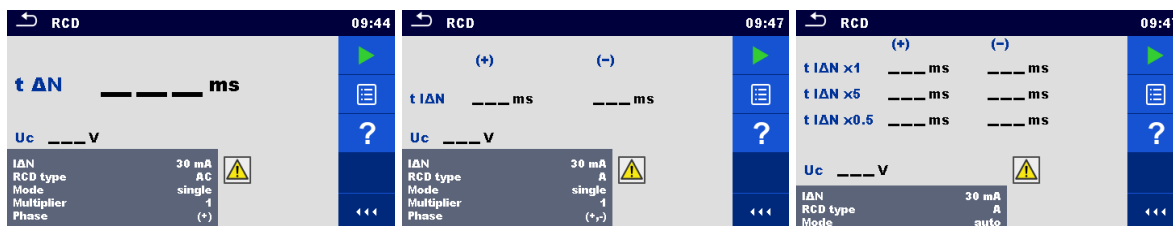


Figure 6.55: RCD measurement menu

Test results / sub-results

- t ΔNtrip out time
- t IΔN x1, (+)trip-out time ($I_{\Delta}=I_{\Delta N}$, (+) positive polarity)
- t IΔN x1, (-)trip-out time ($I_{\Delta}=I_{\Delta N}$, (-) negative polarity)
- t IΔN x5, (+)trip-out time ($I_{\Delta}=5 \times I_{\Delta N}$, (+) positive polarity)
- t IΔN x5, (-)trip-out time ($I_{\Delta}=5 \times I_{\Delta N}$, (-) negative polarity)
- t IΔN x0.5, (+)trip-out time ($I_{\Delta}=\frac{1}{2} \times I_{\Delta N}$, (+) positive polarity)
- t IΔN x0.5, (-)trip-out time ($I_{\Delta}=\frac{1}{2} \times I_{\Delta N}$, (-) negative polarity)
- Idtrip out current
- Id (+)trip-out current ((+) positive polarity)
- Id (-)trip-out current ((-) negative polarity)
- Uc Contact voltage

Test parameters

RCD type	Type [AC, A, B, B+, F]
Nominal current	$I_{\Delta N}$ [10 mA, 15 mA, 30 mA]
Test mode	Mode [single, auto]
Multiplication factor $I_{\Delta N}$	Multiplier [0.5, 1, 5]
Phase Starting polarity in single mode	Phase [+ , - , (+,-)]
RCD Standard	RCD standard [EN 61008 / EN 61009, AS/NZS 3017]
Random phase	Random phase [No, Yes]

Test limits

Test limits for Pass / Fail statuses are set automatically, depending on set parameters.

Test circuit

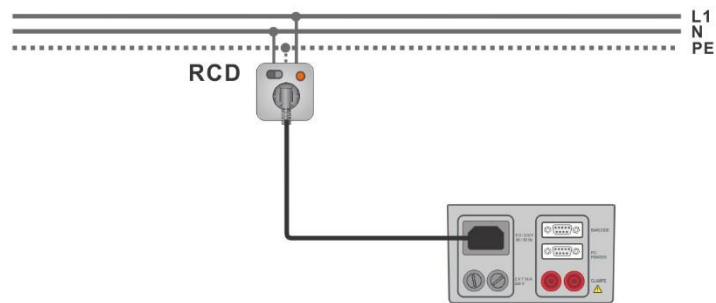


Figure 6.56: RCD test

RCD measurement procedure

- › Connect the instrument to the circuit with RCD (see test circuit above).
- › Switch ON the RCD.
- › Select the RCD function.
- › Set test parameters / limits.
- › Start measurement.
- › Reactivate RCD within 5 s when prompted on the display.
- › Save results (optional).

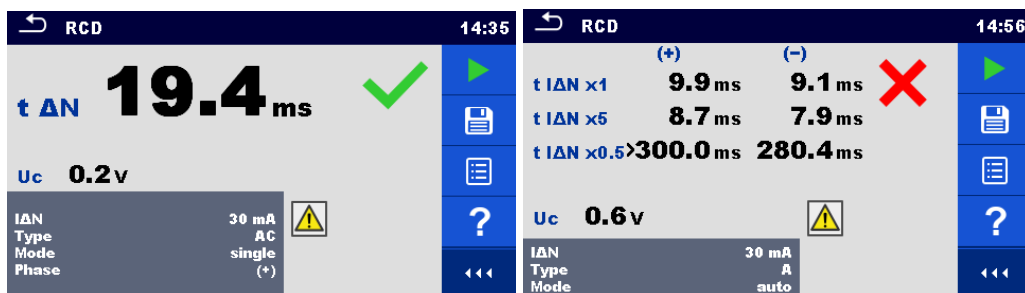


Figure 6.57: Examples of RCD measurement results

6.2.13 PE conductor (PRCD)

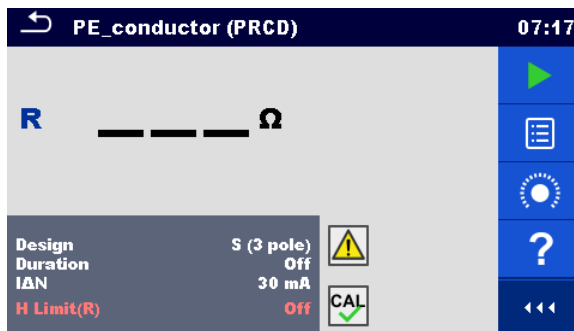


Figure 6.58: PE conductor (PRCD) test menu

Test results / sub-results

R.....Resistance

Result.....Indication that the protection of the varistor in PE connection works properly

Test parameters

Type of PRCD	Design [2 pole, 3 pole, K/Di (varistor), S (3 pole)]
Duration	Duration [Off, 2 s ... 180 s]
Nominal current	IΔN [10 mA, 15 mA, 30 mA, 100 mA, 300 mA]
Nominal current (K/Di varistor)	IΔN [10 mA, 30 mA]

Test limits

Limit	H Limit(R) [Off, 0.01 Ω ... 9 Ω, Custom]
-------	--

Test circuit



Figure 6.59: PE conductor (PRCD) test

PE conductor (PRCD) measurement procedure

- Select the **PE conductor (PRCD)** function.
- Set test parameters / limits.
- Compensate IEC plug adapter (optional).
- Connect device under test to the instrument (see test circuit above).
- Start measurement.
- Switch ON the PRCD within 5 s when prompted on the display. Measurement can be stopped manually or by timer.

- Save results (optional).

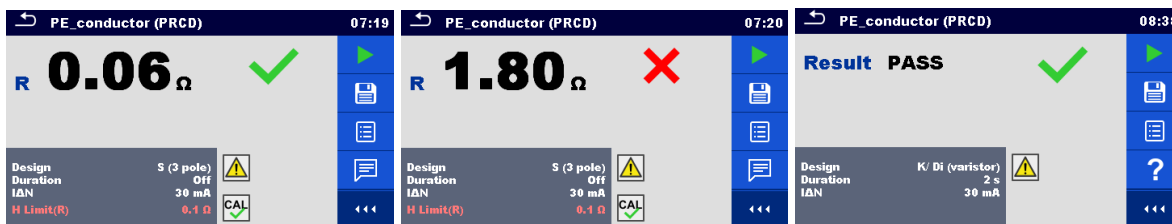


Figure 6.60: Examples of PE conductor (PRCD) results

Note:

- Mains voltage is applied to the PRCD during the test.
- The instrument uses different test methods in regard to the set PRCD type. For 2 pole, 3 pole and S (3 pole) PRCDs the resistance of PE conductor is measured. For K/Di PRCDs the operation of the varistor in the PE connection is tested.
- L and N conductors are not allowed to be crossed in this test. Reconnect the PRCD's plug if necessary.
- PE resistance of IEC plug adapter can be compensated. See chapter 6.2.2.1 *Compensation of test lead / IEC test cable resistance* for details.

6.2.14 Open conductor (PRCD)

In this test the instrument disconnects individual conductors on the supply side and the response of the PRCD is checked.

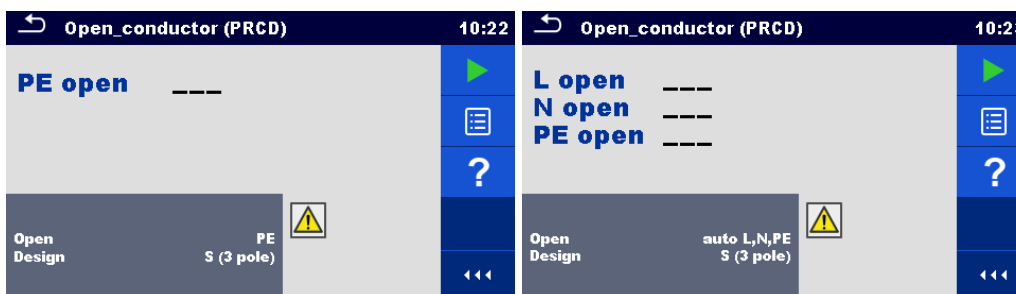


Figure 6.61: Open conductor measurement menu

Test results / sub-results

- L open Result for open L conductor [Pass, Fail]
- N open Result for open N conductor [Pass, Fail]
- PE open Result for open PE conductor [Pass, Fail]

Test parameters / limit

Conductor opened by the instrument	Open [L, N, PE, (auto L,N), (auto L,N,PE)]
Type of PRCD	Design [2 pole, 3 pole, K/Di (varistor), S (3 pole)]

Test circuit



Figure 6.62: Open conductor (PRCD) test

Open conductor (PRCD) measurement procedure

- › Select the Open Conductor (PRCD) function.
- › Set test parameters.
- › Connect the PRCD to the instrument (see test circuit above).
- › Start measurement.
- › Switch ON the PRCD within 5 s when prompted on the display.
- › Reactivate PRCD within 5 s when prompted on the display.
- › Save results (optional).

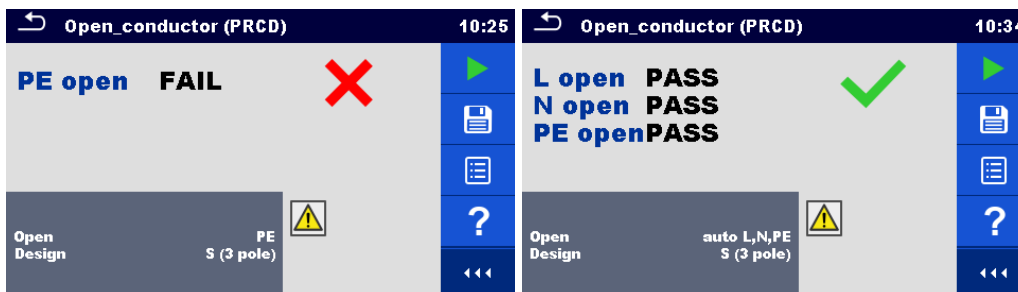


Figure 6.63: Examples of PRCD measurement results

6.2.15 PRCD PE probe test

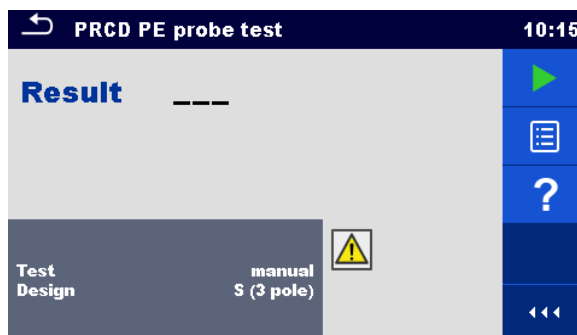


Figure 6.64: PRCD PE probe test menu

Test results / sub-results

Result.....Indication of the test [Pass, Fail]

Test parameters / limits

Test mode	Test [manual, auto]
Type of PRCD	Design [2 pole, 3 pole, K/Di (varistor), S (3 pole)]

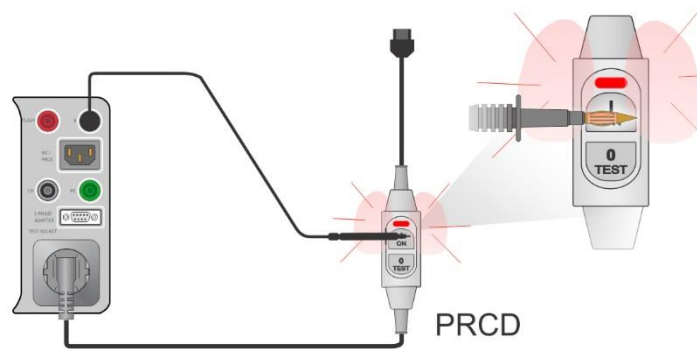
Test circuits

Figure 6.65: PRCD PE probe test (manual)

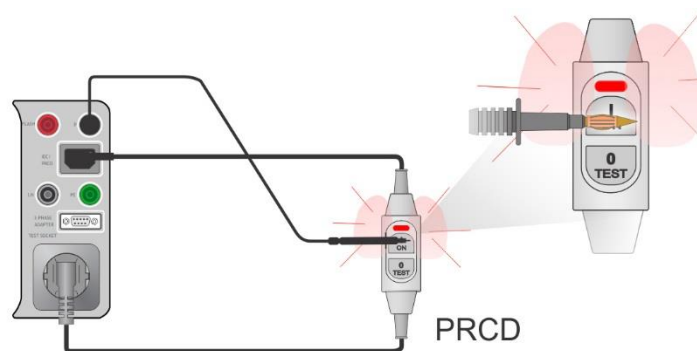


Figure 6.66: PRCD PE probe test (auto)

PRCD PE probe test measurement procedure (Test = manual)

- › Select the **PRCD PE probe test** function.
- › Set test parameters (Test = manual)
- › Connect the PRCD to be tested to the instrument (see test circuits above).
- › Start measurement.
- › The instrument applies power to the mains test socket for 10 s (timer is displayed).
- › Switch ON the PRCD and with test probe touch the On button of the PRCD (see test circuit above), while power is on. If the PRCD has built in detection for high voltage on PE it will trip.
- › Manually apply test result status and end the test.
- › Save results (optional).

PRCD PE probe test measurement procedure (Test = auto)

- › Select the **PRCD PE probe test** function.
- › Set test parameters (Test = auto)
- › Connect the PRCD to be tested to the instrument (see test circuits above).
- › Start measurement.
- › Switch ON the PRCD within 5 s when prompted on the display.
- › Reactivate PRCD within 5 s when prompted on the display.
- › The instrument applies power to the mains test socket for 10 s (timer is displayed).
With test probe touch the On button of the PRCD (see test circuit above). If the PRCD has built in detection for high voltage on PE it will trip.
- › Test result status is automatically applied and test is ended.
- › Save results (optional).

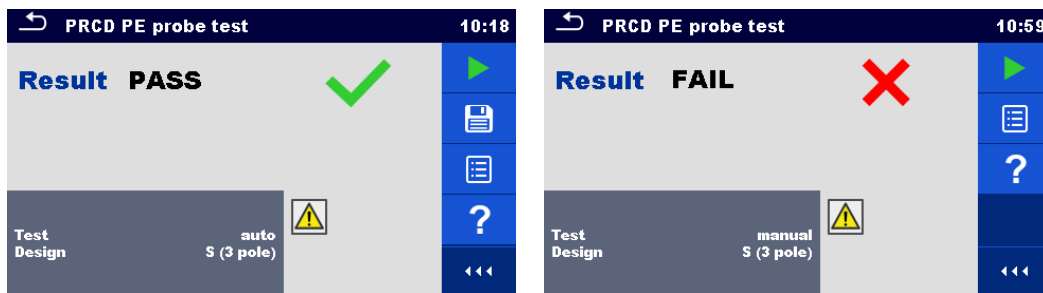


Figure 6.67: Examples of PRCD PE probe test

Notes:

- › A safe but high voltage is applied to the test lead during the test. Do not touch the exposed tip at the end of the test lead. Risk of not dangerous but unpleasant electric shock!

6.2.16 Polarity

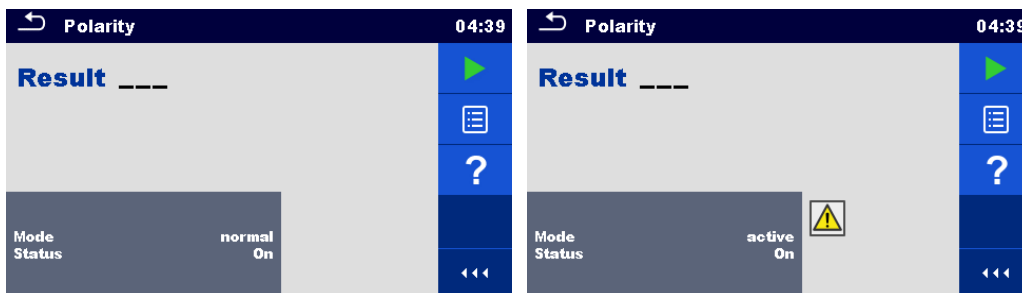


Figure 6.68: Polarity test menus

Test results / sub-results

Result..... Indication of the test [Pass, Description of the fault]

Test parameters / limits

Test mode	Mode [normal, active]
Test status	Status [On, Off] (disable test status within Auto Sequence® for K/Di PRCD)

Test circuits

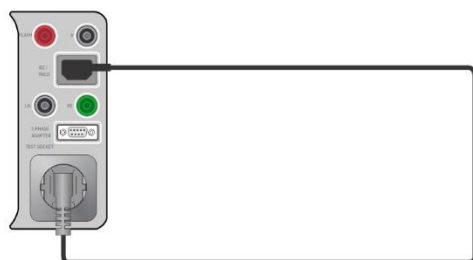


Figure 6.69: Polarity test (manual)

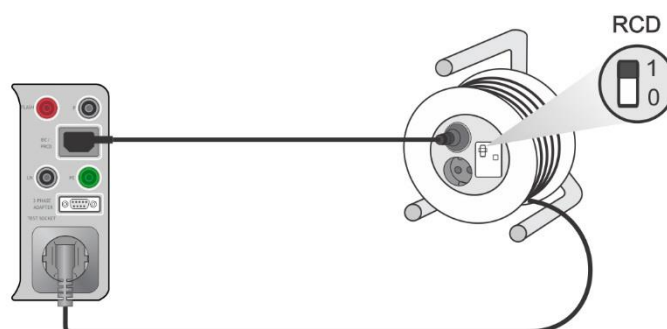


Figure 6.70: Polarity test (auto)

Polarity measurement procedure (Mode = normal)

- › Select the **Polarity** function.
- › Set test parameters (Mode = normal).
- › Connect the cable to be tested to the instrument (see test circuits above).
- › Start measurement.
- › Save results (optional).

Polarity measurement procedure (Mode = active)

- › Select the **Polarity** function.
- › Set test parameters (Mode = active).
- › Connect the (PRCD) cable to be tested to the instrument (see test circuits above).
- › Start measurement.
- › Switch ON the switch / PRCD within 5 s when prompted on the display.
- › Save results (optional).

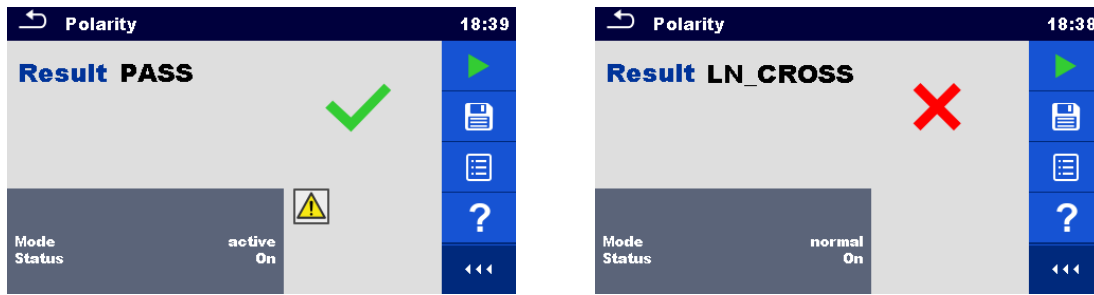


Figure 6.71: Examples of Polarity test

Note:

- Active polarity test is intended for testing cords equipped with (P)RCD or mains operated switches.

6.2.17 Clamp current

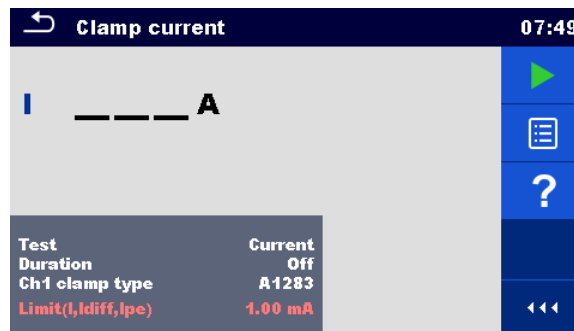


Figure 6.72: Clamp current test menu

Test results / sub-results

ICurrent

Test parameters

Indication of which current is measured with clamps	Test [Differential leakage, PE leakage, Current]
Duration	Duration [Off, 2 s ...180 s]
Current clamp model	Ch1 clamp type [A1283]

Test limits

High Limit (I, Idiff, Ipe)	Limit(I,Idiff,Ipe) [Off, 0.25 mA ... 15.0 mA]
----------------------------	---

Test circuit

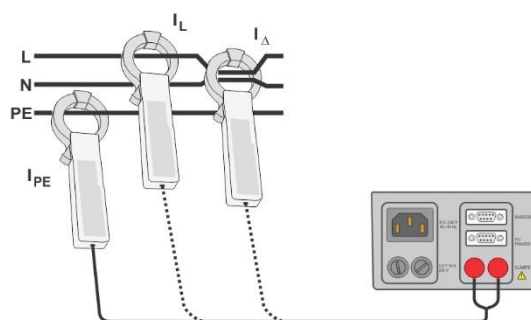


Figure 6.73: Clamp current

Clamp current measurement procedure

- › Select the **Clamp current** function.
- › Set test parameters / limits.
- › Connect the current clamp to the instrument.
- › Embrace wire(s) that has to be measured with current clamp (see test circuits above).
- › Start measurement.
- › Measurement can be stopped manually or by timer.
- › Save results (optional).



Figure 6.74: Examples of Clamp current measurement results

Note:

- › The frequency range of this measurement is limited. This measurement cannot be used for measuring leakage currents of appliances that are able to generate leakage currents with frequencies above 10 kHz or above the specified frequency range of the clamp.

6.2.18 Insulation resistance – Riso (welding equipment)

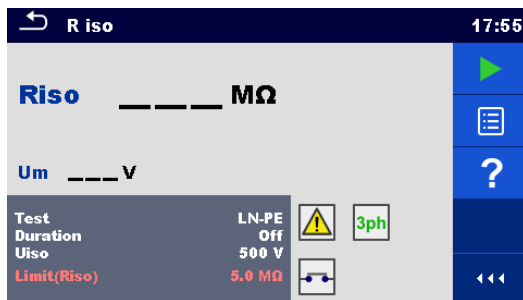


Figure 6.75: Insulation resistance (welding equipment) test menus

Test results / sub-results

RisoInsulation resistance
 Um.....Test voltage

Test parameters

Test type	Test [LN-W, W-PE, LN-PE, LN (Class II) - P]
Duration	Duration [Off, 2 s ... 180 s]
Nominal test voltage	Uiso [500 V]dc

Test limits

Low Limit (Riso)	Limit(Riso) [Off, 2.5 MΩ, 5.0 MΩ]
------------------	-----------------------------------

Test circuit, Riso (welding equipment) measurement procedure

- Select the **Riso** function.
- Set test parameters / limits.
- Connect METREL 3-phase adapter (A 1422) to the instrument*.
- Connect device under test to the 3-phase adapter*.
- Start measurement.
- Measurement can be stopped manually or by timer.
- Save results (optional).

*For more information refer to chapter *Measurements according to IEC/ EN 60974-4 – Insulation resistance in 3-phase adapter* user manual.



Figure 6.76: Examples of Insulation resistance (welding equipment) measurement results

Note:

- This test is applicable only with connected METREL 3-phase adapter (A1422).

6.2.19 Welding Circuit Leakage – I leak (W-PE)

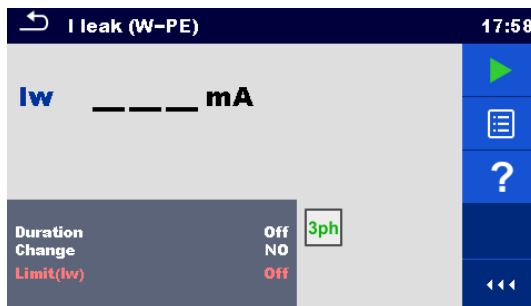


Figure 6.77: I leak W-PE test menu

Test results / sub-results

Iw.....Leakage current

Test parameters

Duration	Duration [Off, 2 s ... 180 s]
Change status	Change [YES, NO] YES: The instrument measures leakage current in two sequential steps with delay* in between. The phase voltage is firstly applied to the right live output of the mains test socket and secondly to the left live output of the mains test socket. NO: The phase voltage is applied only to the right live output of the mains test socket.
*Delay time	Delay [0.2 s ... 5 s]

Test limits

High Limit (Iw)	Limit(Iw) [Off, 3.50 mA ... 10.00 mA]
-----------------	--

Test circuit, I leak (W-PE) measurement procedure

- › Select the **I leak (W-PE)** function.
- › Set test parameters / limits.
- › Connect METREL 3-phase adapter (A 1422) to the instrument*.
- › Connect device under test to the 3-phase adapter*.
- › Start measurement.
- › Measurement can be stopped manually or by timer.
- › Save results (optional).

*For more information refer to chapter *Measurements according to IEC/ EN 60974-4 – Welding circuit leakage current in 3-phase adapter* user manual.

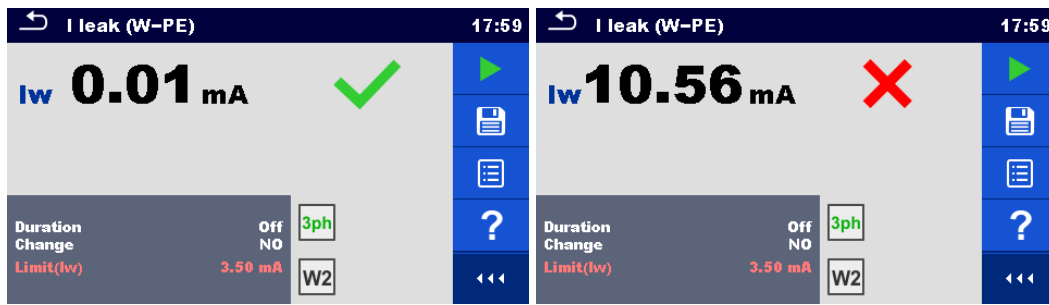


Figure 6.78: Examples of I leak W-PE Leakage measurement results

Note:

- This test is applicable only with connected METREL 3-phase adapter (A1422).

6.2.20 Primary Leakage

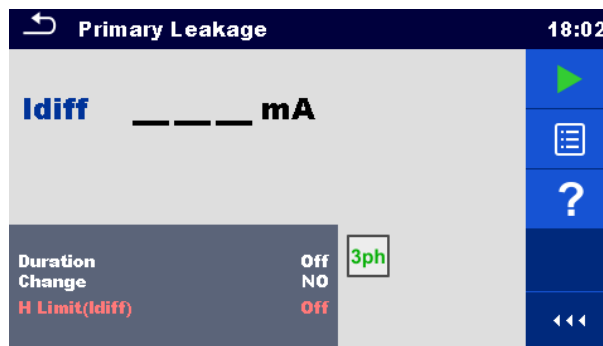


Figure 6.79: Primary Leakage menu

Test results / sub-results

IdiffPrimary leakage current

Test parameters

Duration	Duration [Off, 2 s ... 180 s]
Change status	Change [YES, NO] YES: The instrument measures leakage current in two sequential steps with delay* in between. The phase voltage is firstly applied to the right live output of the mains test socket and secondly to the left live output of the mains test socket. NO: The phase voltage is applied only to the right live output of the mains test socket.
*Delay time	Delay [0.2 s ... 5 s]

Test limits

High Limit (Idiff)	H Limit(Idiff) [Off, 3.50 mA ... 10.00 mA, Custom]
--------------------	--

Test circuit, Primary Leakage measurement procedure

- › Select the **Primary Leakage** function.
- › Set test parameters / limits.
- › Connect METREL 3-phase adapter (A 1422) to the instrument*.
- › Connect device under test to the 3-phase adapter*.
- › Start measurement.
- › Measurement can be stopped manually or by timer.
- › Save results (optional).

*For more information refer to chapter *Measurements according to IEC/ EN 60974-4 – Primary Leakage current in 3-phase adapter* user manual.

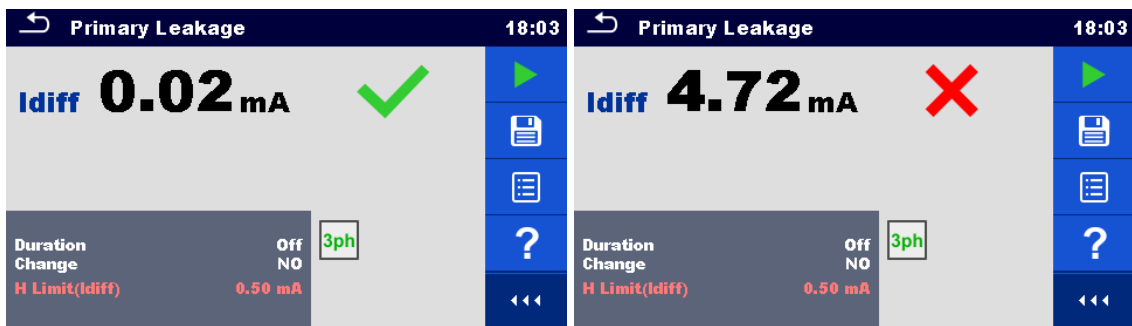


Figure 6.80: Examples of ILeak W-PE Leakage measurement results

Notes:

- › This test is applicable only with connected METREL 3-phase adapter (A1422).
- › The differential current measurement principle is used for this test.

6.2.21 No-load voltage

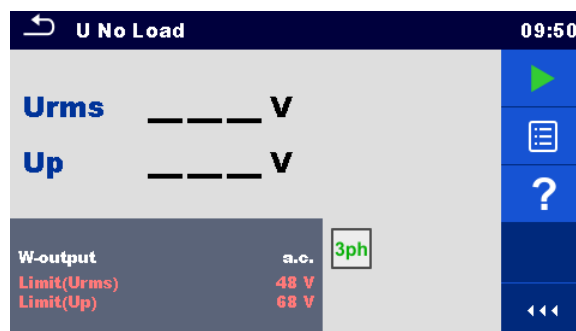


Figure 6.81: No-load voltage menu

Test results / sub-results

Urms.....maximum no-load rms value
 Up.....maximum no-load peak value

Test parameters

Voltage type on welding output	W-output [a.c., d.c.]
--------------------------------	-----------------------

Test limits

Limit (a.c. rms)	Limit (Urms) [Off, 48 V, 80 V, 100 V]
Limit (a.c. peak)	Limit (Up) [Off, 68 V, 113 V, 141 V]
Limit (d.c. peak)	Limit (Up) [Off, 68 V, 113 V, 141 V]

Test circuit, No-load voltage measurement procedure

- › Select the **U No Load** function.
- › Set test parameters / limits.
- › Connect METREL 3-phase adapter (A 1422) to the instrument*.
- › Connect device under test to the 3-phase adapter*.
- › Start measurement.
- › Press 'Next' when the message **Ready** is displayed.
- › Save results (optional).

*For more information refer to chapter *Measurements according to IEC/ EN 60974-4 – No load voltage in 3-phase adapter user manual.*

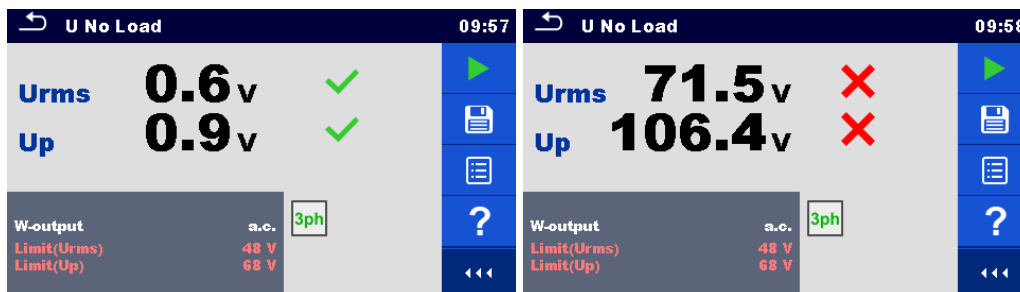


Figure 6.82: Examples of No-load voltage measurement results

Note:

- › This test is applicable only with connected METREL 3-phase adapter (A1422).

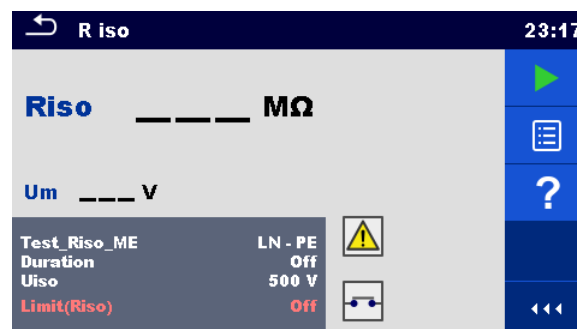
6.2.22 Insulation resistance – Riso (medical equipment)

Figure 6.83: Insulation resistance (medical equipment) test menus

Test results / sub-results

RisoInsulation resistance

Um.....Test voltage

Test parameters

Test	Test_Riso_ME [LN-PE, LN-P/S, LN-AP, PE-AP]
Duration	Duration [Off, 2 s ... 180 s]
Nominal test voltage	Uiso [500 V]

Test limit

Limit (Riso)	Limit(Riso) [Off, 2 M Ω ... 70 M Ω]
--------------	--

Test circuits

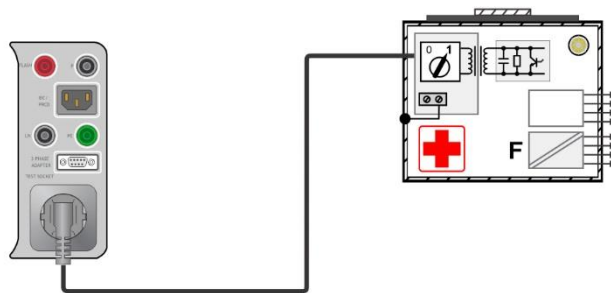


Figure 6.84: Insulation resistance – LN-PE

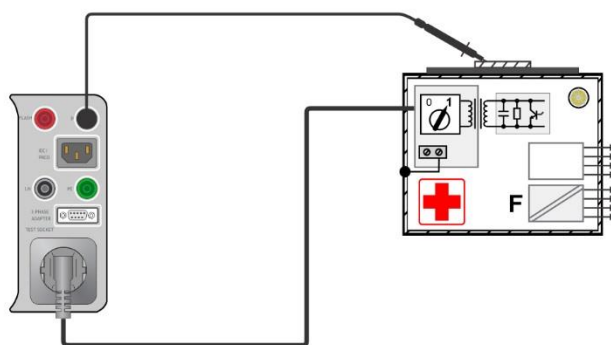


Figure 6.85: Insulation resistance – LN-P/S

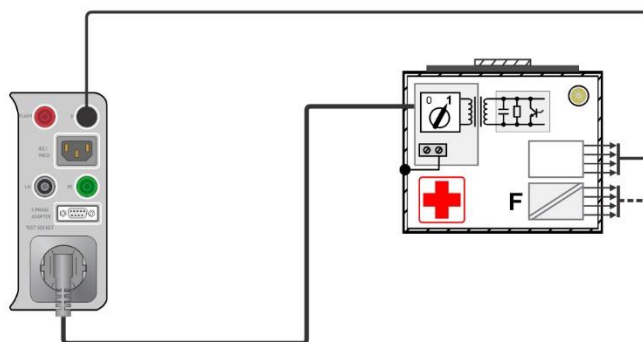


Figure 6.86: Insulation resistance – LN-AP

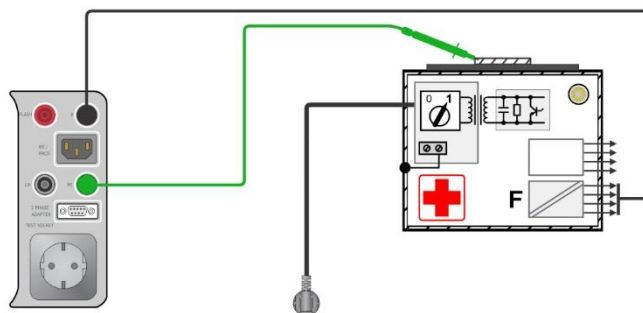


Figure 6.87: Insulation resistance – PE-AP

RISO measurement procedure

- › Select the **Riso** function.
- › Set test parameters / limits.
- › Connect device under test to the instrument (see test circuits above).
- › Start measurement.
- › Measurement can be stopped manually or by timer.
- › Save results (optional).



Figure 6.88: Examples of Insulation resistance (medical equipment) measurement results

6.2.23 Equipment Leakage (medical equipment)

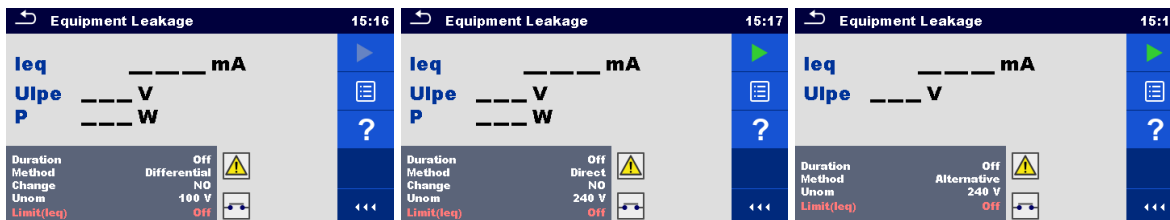


Figure 6.89: Equipment leakage measurement menu

Test results / sub-results

- leqEquipment leakage current
- Ulpe.....Measured voltage between phase and earth
- P.....Active power

Test parameters

Duration	Duration [Off, 2 s ... 180 s]
Test method	Method [Alternative, Direct, Differential]
Change status	Change [YES, NO] YES: The instrument measures leakage current in two sequential steps with delay* in between. The phase voltage is firstly applied to the right live output of the mains test socket and secondly to the left live output of the mains test socket. NO: The phase voltage is applied only to the right live output of the mains test socket.
*Delay time	Delay [0.2 s ... 5 s]

Nominal line to earth voltage whose value corresponds to the nominal mains voltage	Unom [100 V ... 240 V]
--	------------------------

Test limits

Limit (Ieq) (alternative)	Limit(Ieq) [Off, 500 µA, 1000 µA]
Limit (Ieq) (direct, differential)	Limit(Ieq) [Off, 100 µA, 500 µA]

Test circuits

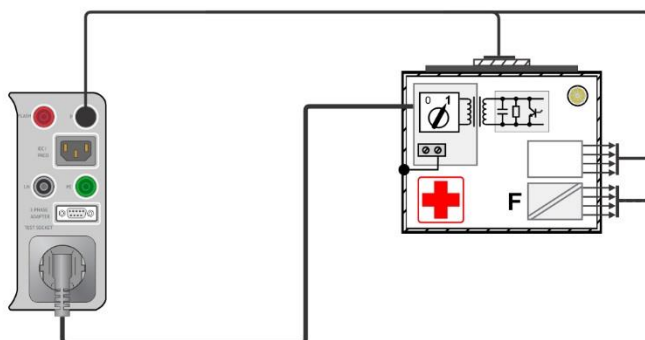


Figure 6.90: Equipment Leakage (alternative) on Class I ME

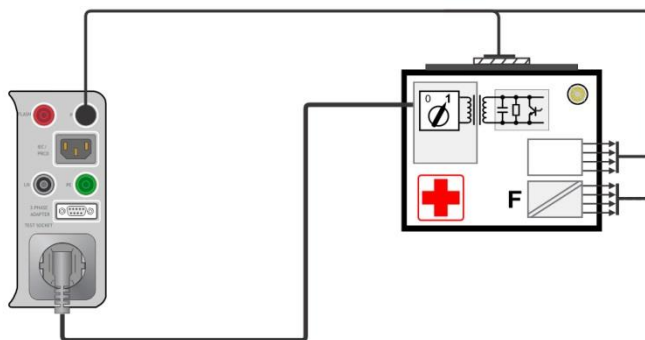


Figure 6.91: Equipment Leakage (alternative) on Class II ME

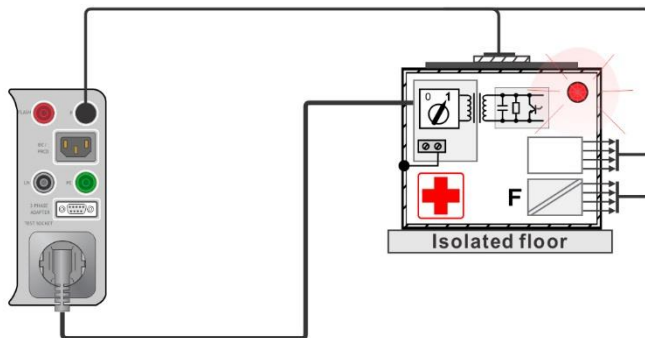


Figure 6.92: Equipment Leakage (direct) on Class I

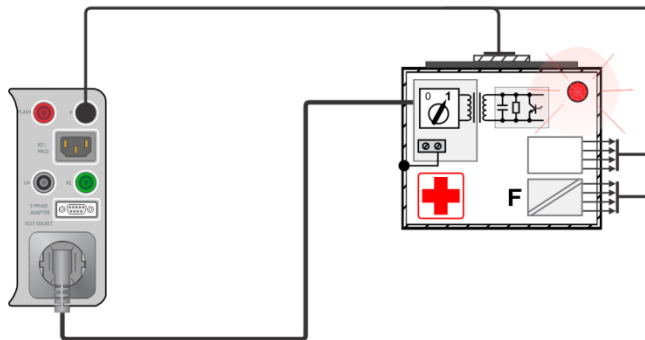


Figure 6.93: Equipment Leakage (differential) on Class I ME

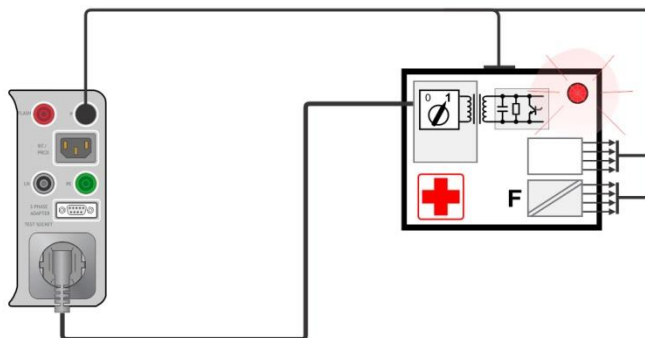


Figure 6.94: Equipment Leakage (direct, differential) on Class II ME

Equipment Leakage measurement procedure

- › Select the **Equipment Leakage** function.
- › Set test parameters / limits.
- › Connect device under test to the instrument (see test circuits above).
- › Start measurement.
- › Measurement can be stopped manually or by timer.
- › Save results (optional).

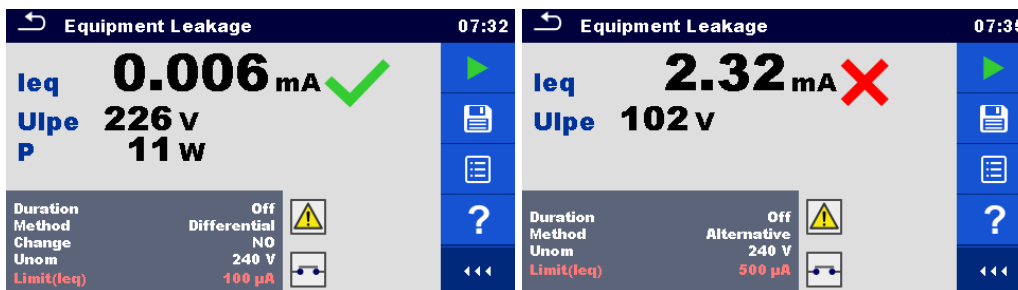


Figure 6.95: Examples of Equipment leakage measurement results

6.2.24 Applied Part Leakage (medical equipment)

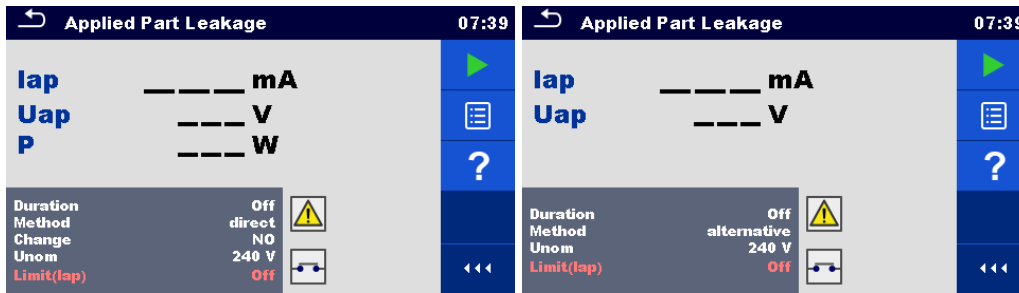


Figure 6.96: Applied part leakage measurement menu

Test results / sub-results

- lap.....Applied part leakage current
- Uap.....Voltage between applied part and earth during measurement
- P.....Active power

Test parameters

Duration	Duration [Off, 2 s ... 180 s]
Test method	Method [Alternative, Direct]
Change status	Change [YES, NO] YES: The instrument measures leakage current in two sequential steps with delay* in between. The phase voltage is firstly applied to the right live output of the mains test socket and secondly to the left live output of the mains test socket. NO: The phase voltage is applied only to the right live output of the mains test socket.
*Delay time	Delay [0.2 s ... 5 s]
Nominal line to earth voltage whose value corresponds to the nominal mains voltage	Unom [100 V ... 240 V]

Test limits

Limit (lap) (alternative, direct)	Limit(lap) [Off, 50 µA, 5000 µA]
-----------------------------------	----------------------------------

Test circuit

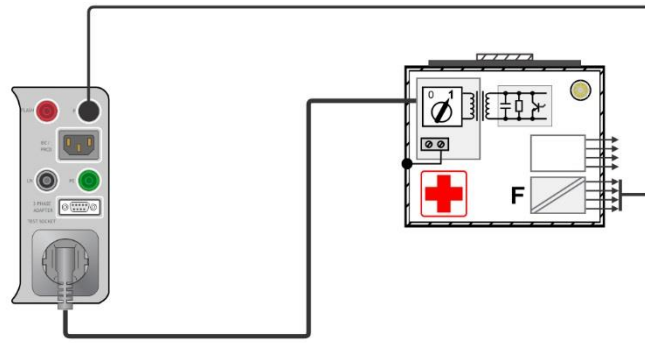


Figure 6.97: Applied part leakage (alternative) on Class I ME

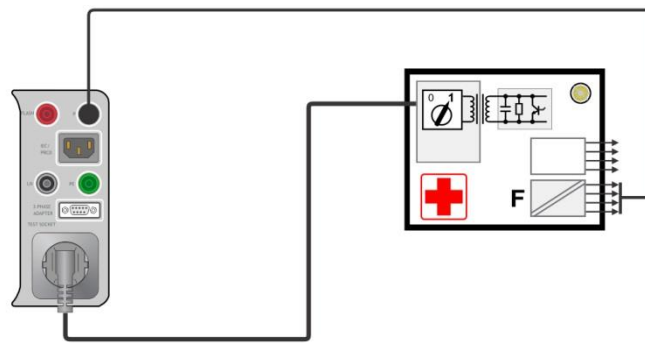


Figure 6.98: Applied part leakage (alternative) on Class II ME

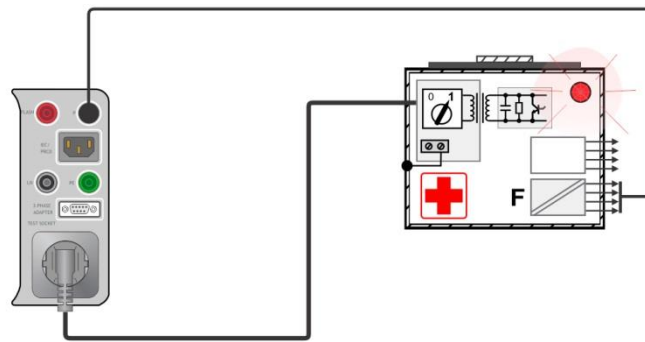


Figure 6.99: Applied part leakage (direct) on Class I ME

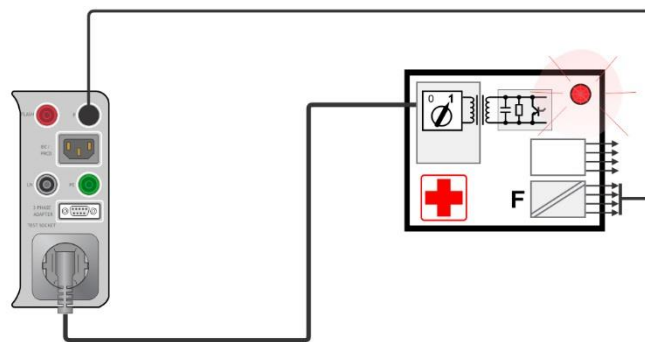


Figure 6.100: Applied part leakage (direct) on Class II ME

Applied part leakage measurement procedure

- › Select the **Applied part leakage** function.
- › Set test parameters / limits.
- › Connect device under test to the instrument (see test circuits above).
- › Start measurement.
- › Measurement can be stopped manually or by timer.
- › Save results (optional).

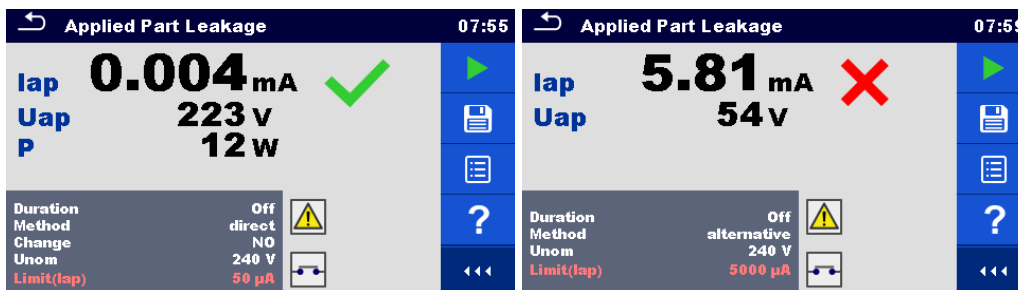


Figure 6.101: Examples of Applied part leakage measurement results

6.2.25 Touch Current (medical equipment)

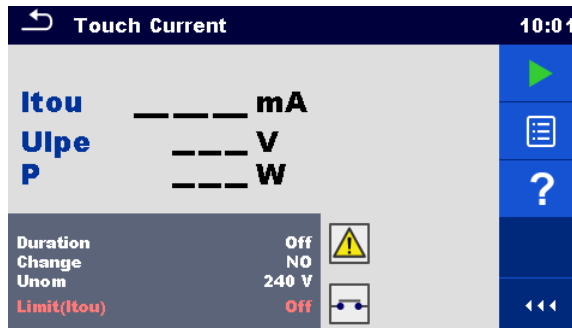


Figure 6.102: Touch current measurement menu

Test results / sub-results

ItouTouch current
 Ulpe.....Measured voltage between phase and earth
 P.....Active power

Test parameters

Duration	Duration [Off, 2 s ... 180 s]
Change status	Change [YES, NO] YES: The instrument measures leakage current in two sequential steps with delay* in between. The phase voltage is firstly applied to the right live output of the mains test socket and secondly to the left live output of the mains test socket. NO: The phase voltage is applied only to the right live output of the mains test socket.
*Delay time	Delay [0.2 s ... 5 s]

Nominal line to earth voltage whose value corresponds to the nominal mains voltage	Unom [100 V ... 240 V].
--	-------------------------

Test limits

Limit (Itou)	Limit(Itou) [Off, 100 µA]
--------------	---------------------------

Test circuit

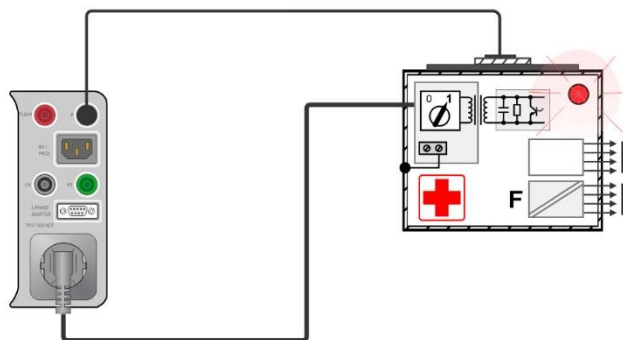


Figure 6.103: Touch current

Applied part leakage measurement procedure

- › Select the **Touch Current** function.
- › Set test parameters / limits.
- › Connect device under test to the instrument (see test circuit above).
- › Start measurement.
- › Measurement can be stopped manually or by timer.
- › Save results (optional).



Figure 6.104: Examples of Touch current measurement results

6.2.26 Functional test

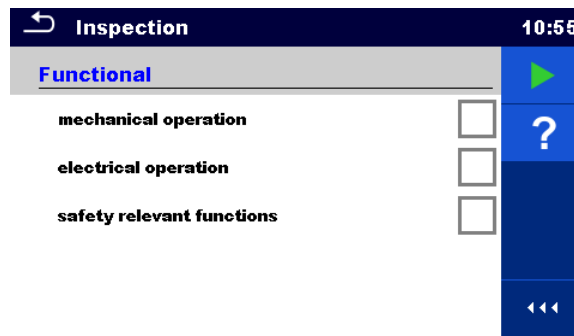


Figure 6.105: Functional test menu

Test parameters (optional)

For the optional Power measurement the parameters and limits are the same as set in Power test.

Test circuit

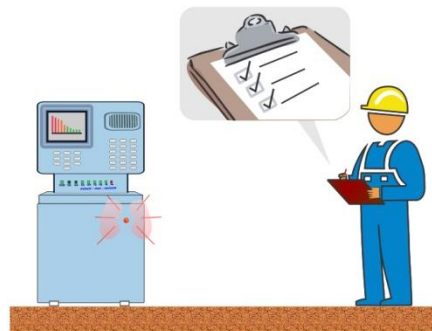


Figure 6.106: Functional test

Functional test inspection procedure

- › Select the appropriate **Functional test** function.
- › Start the inspection.
- › Power on the appliance through the mains test socket. Power measurement screen is displayed (optional).
- › Perform the functional inspection of the appliance / equipment.
- › Apply appropriate ticker(s) to items of inspection.
- › End inspection.
- › Save results (optional).

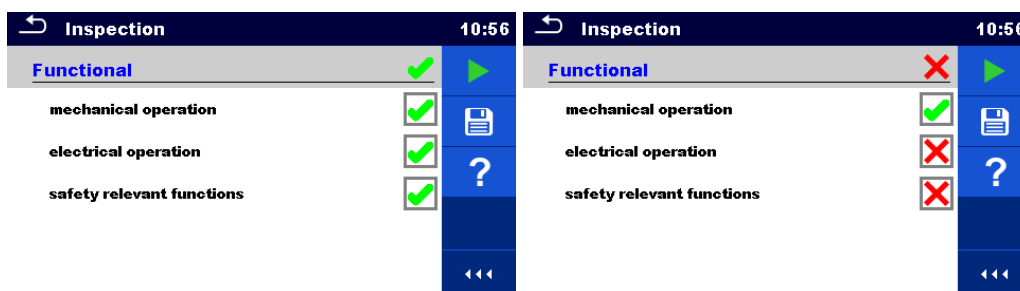


Figure 6.107: Examples of Functional test results

7 Auto Sequences®

Pre-programmed sequences of measurements can be carried out in Auto Sequences® menu. The sequence of measurements, their parameters and flow of the sequence can be programmed. The results of an Auto sequence® can be stored in the memory together with all related information.

Auto Sequences® can be pre-programmed on PC with the Metrel ES Manager software and uploaded to the instrument. On the instrument parameters and limits of individual single test in the Auto Sequence® can be changed / set.

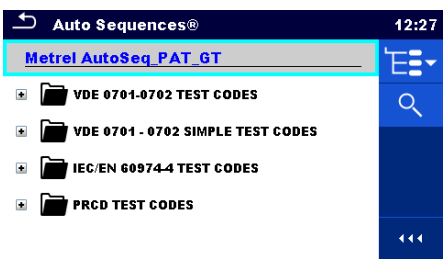

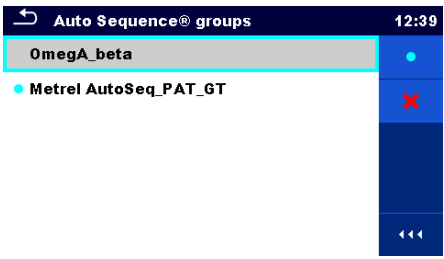

7.1 Selection of Auto Sequences®

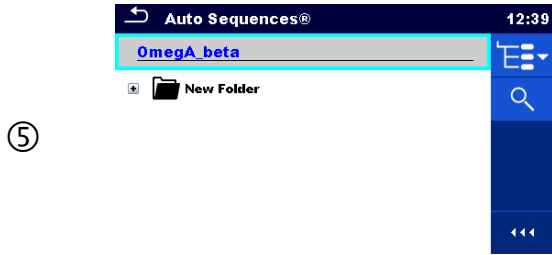
The Auto Sequence® list from Auto Sequence® groups menu should be selected first. Refer to chapter 4.11 *Auto Sequence® groups* for more details.

7.1.1 Selecting an active Auto Sequence® group in Auto Sequences® menu

Auto Sequences® and Auto Sequence® group menus are interconnected so an active Auto Sequence® group can be selected also in the Auto Sequences® menu.

Procedure

- | | | |
|---|---|--|
| ① |  | Tap on the active Auto Sequence® group header in Auto Sequences® Menu. |
| ② |  | Opens a list of Auto Sequence® groups in Control panel. |
| ③ |  | Selects desired Auto Sequence® group from a list of groups. |
| ④ |  | Confirms a new selection. |

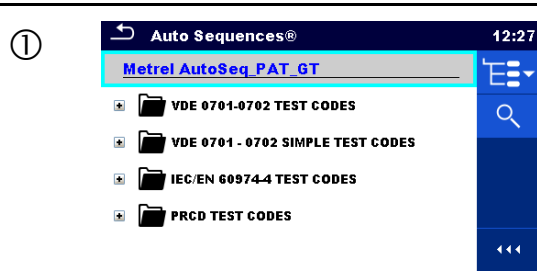


New Auto Sequence® group is selected and all Auto Sequences® within that group are displayed on the screen.

7.1.2 Searching in Auto Sequences® menu

In Auto Sequence® menu it is possible to search for Auto Sequences® on base of their Name or Short code.

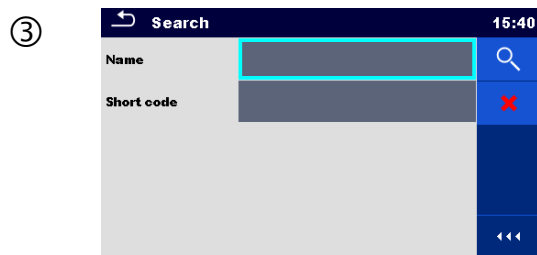
Procedure



Search function is available from the active Auto Sequence® group header line.



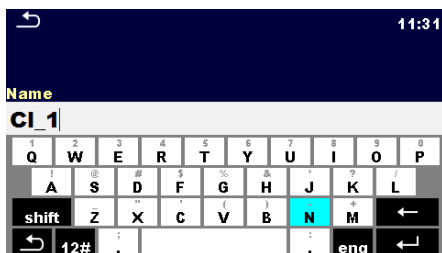
Select Search in control panel to open Search setup menu.



The parameters that can be searched for are displayed in the Search setup menu.





The parameters that can be searched for are displayed in the Search setup menu.



The search can be narrowed by entering a text in the Name and Short code fields.

Strings can be entered by using the on-screen keyboard.

③b		Clears all filters. Sets filters to default value.
④		Searches through the active Auto Sequence® group according to the set filters. The results are shown in the Search results screen presented on <i>Figure 7.1</i> and <i>Figure 7.2</i> .

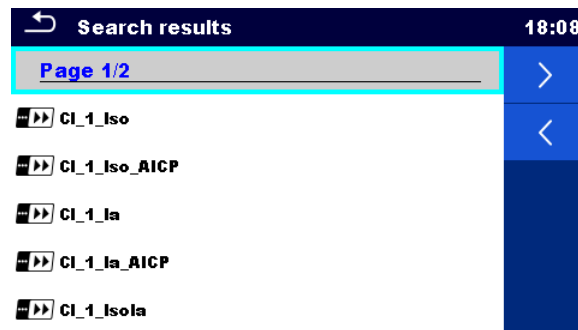


Figure 7.1: Search results screen – Page view

Options:



Next page.



Previous page.

Note:

Search result page consist of up to 50 results.

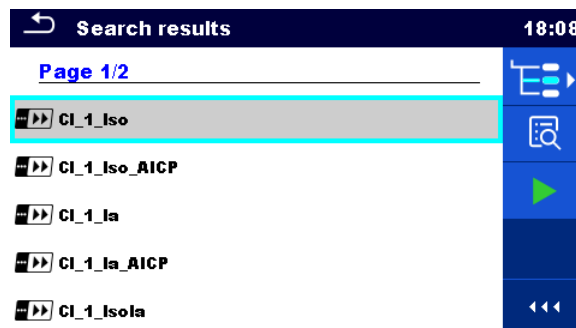


Figure 7.2: Search results screen with Auto Sequences® selected

Options:



Goes to location in Auto Sequences® menu.



Goes to Auto Sequence® view menu.



Starts the selected Auto Sequence®.

7.1.3 Organization of Auto Sequences® in Auto Sequences® menu

The Auto Sequences® to be carried out can be selected from the Main Auto Sequences® menu. This menu can be organized in a structural manner with folders, sub-folders and Auto Sequences®. Auto Sequence® in the structure can be the original Auto Sequence® or a shortcut to the original Auto Sequence®.

Auto Sequences® marked as shortcuts and the original auto Sequences® are coupled. Changing of parameters or limits in any of the coupled Auto Sequences® will influence on the original Auto Sequence® and all its shortcuts.

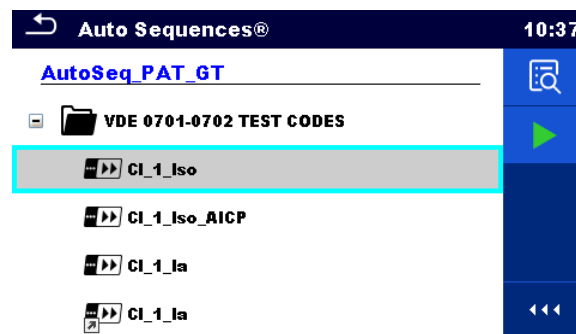
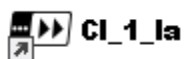


Figure 7.3: Examples of organized Auto Sequences® in main Auto Sequences® menu

Options:



The original Auto Sequence®.



A shortcut to the original Auto Sequence®.



Enters menu for more detail view of selected Auto sequence®.

This option should also be used if the parameters / limits of the selected Auto Sequence® have to be changed. Refer to chapter 7.2.1 *Auto Sequence® view* menu for more information.



Starts the selected Auto Sequence®.

The instrument immediately starts the Auto sequence®.

7.2 Organization of an Auto Sequence®

An Auto Sequence® is divided into three phases:

- Before starting the first test the Auto Sequence® view menu is shown (unless it was started directly from the Main Auto Sequences® menu). Parameters and limits of individual measurements can be set in this menu.
- During the execution phase of an Auto Sequence®, pre-programmed single tests are carried out. The sequence of single tests is controlled by pre-programmed flow commands.
- After the test sequence is finished the Auto Sequence® result menu is shown. Details of individual tests can be viewed and the results can be saved to Memory organizer.

7.2.1 Auto Sequence® view menu

In the Auto Sequence® view menu, the header and the single tests of selected Auto Sequence® are displayed. The header contains Name, Short code and description of the Auto Sequence®. Before starting the Auto Sequence®, test parameters / limits of individual measurements can be changed.

7.2.1.1 Auto Sequence® view menu (Header is selected)

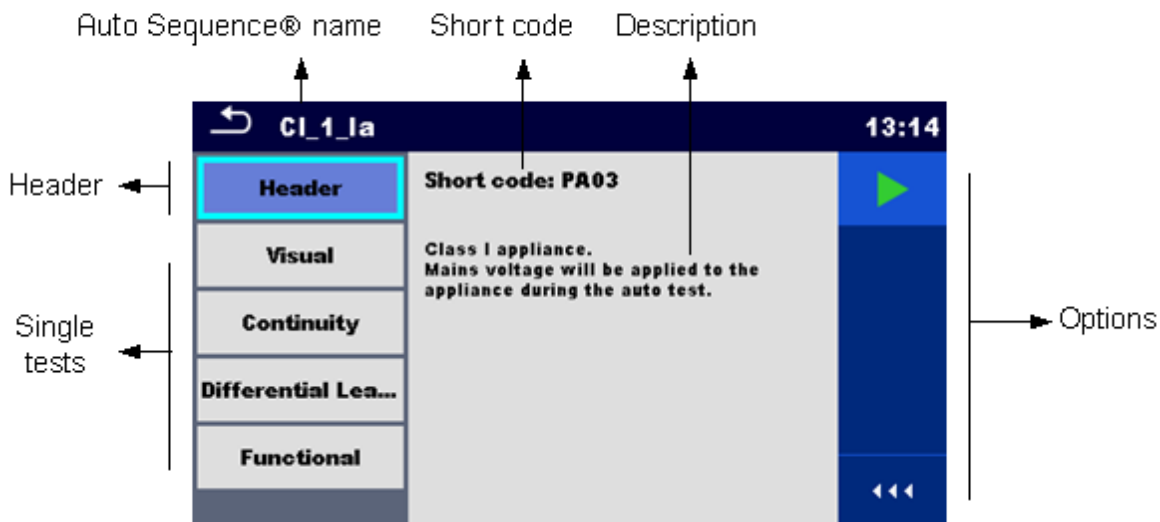


Figure 7.4: Auto Sequence® view menu – Header selected

Options:



Starts the Auto Sequence®.

7.2.1.2 Auto Sequence® view menu (measurement is selected)

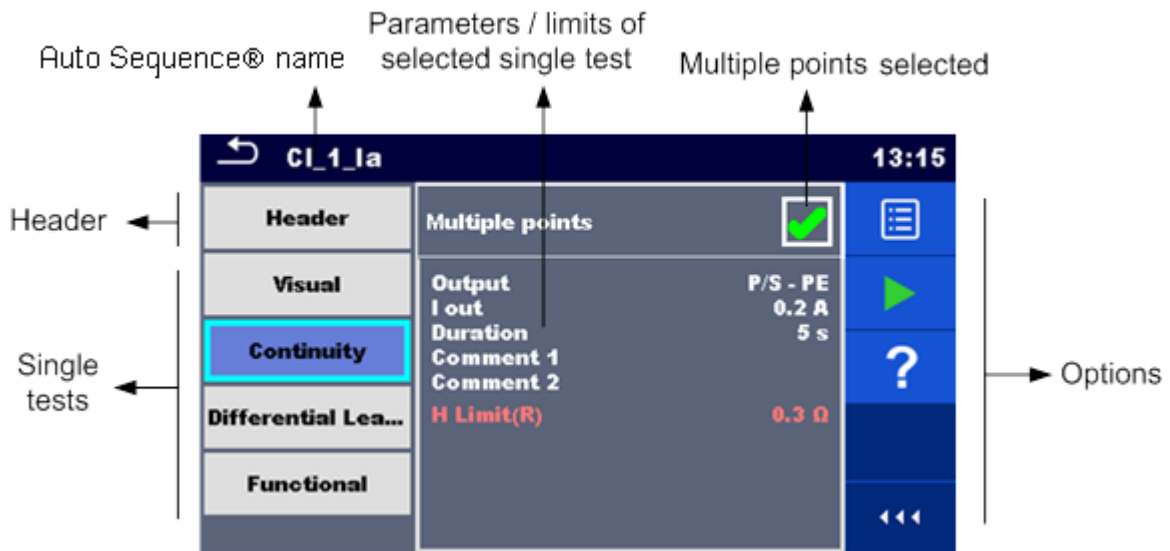


Figure 7.5: Auto Sequence® view menu – measurement selected

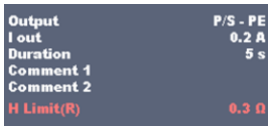
Options:



Selects single test.



Opens menu for changing parameters and limits of selected measurements.



Refer to chapter 6.1.1.2 *Setting* parameters and limits of single tests for more information how to change measurement parameters and limits.



Starts the Auto Sequence®.



Opens help screens. Refer to chapter 6.1.3 *Help screens* for more information.



Selects Multiple points.





Sets operation mode for multiple points. For more information see chapter 7.2.1.4 *Managing multiple points*.



7.2.1.3 Indication of Loops



The attached 'x3' at the end of single test name indicates that a loop of single tests is programmed. This means that the marked single test will be carried out as many times as the number behind the 'x' indicates. It is possible to exit the loop before, at the end of each individual measurement.

7.2.1.4 Managing multiple points

If the device under test has more than one test point for an individual single test and the selected Auto Sequence® predicts only one test point (one single test) it is possible to change the Auto Sequence® appropriately. Single tests with enabled Multiple points ticker will be executed in a continuous loop. It is possible to exit the loop anytime at the end of each individual measurement.

The Multiple points setting is valid only for the actual Auto Sequence®. If the user often tests appliances with more than one test points it is recommended to program a special Auto Sequence® with pre-programmed loops.

7.2.2 Step by step execution of Auto Sequences®

While the Auto Sequence® is running, it is controlled by pre-programmed flow commands. Examples of actions controlled by flow commands are:

- pauses during the Auto Sequence®
- buzzer Pass / Fail sound after the tests
- pre-set data off appliances
- expert mode for Inspections
- skip non-safety notifications
- etc.

The actual list of flow commands is available in chapter *E.5 Description of flow commands*.

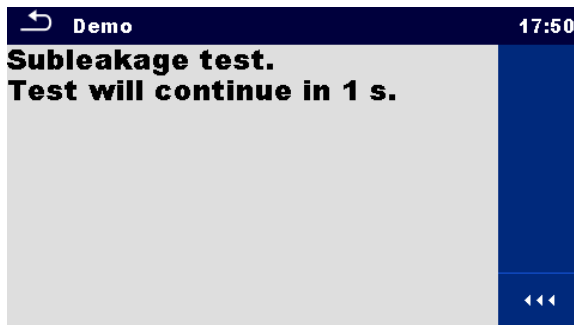


Figure 7.6: Auto Sequence® – Example of a pause with message

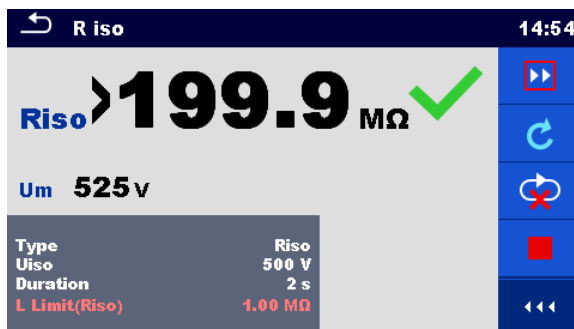


Figure 7.7: Auto Sequence® – Example of a finished measurement with options for proceeding

Options (during execution of an Auto Sequence®):

	Proceeds to the next step in the test sequence.
	Repeats the measurement. Displayed result of a single test will not be stored.
	Ends the Auto Sequence® and goes to Auto Sequence® result screen. Refer to chapter 7.2.3 <i>Auto Sequence® result</i> screen for more information.
	Exits the loop of single tests and proceeds to the next step in the Auto Sequence®.
	Opens menu for viewing parameters and limits of a current measurement.
on	
	Adds comment. The instrument opens keypad for entering a comment to a current measurement.

The offered options in the control panel depend on the selected single test, its result and the programmed test flow.

Notes:

- During Auto Sequences® the popup Warning messages (see chapter 4.5 *Symbols and messages*) are displayed only before the single test inside one Auto Sequence®. This default setting can be changed with appropriate flow command. For more information about programming Auto Sequences® refer to chapter *Appendix E Programming of Auto Sequences® on Metrel ES Manager*.
- If Inspection Expert mode flow command is set, the visual inspection screen and Functional inspection screen are displayed for 1 second and an overall PASS is automatically applied at the end of test. In between, the automatic procedure can be stopped and statuses can be applied manually.

7.2.3 Auto Sequence® result screen

After the Auto Sequence® is finished the Auto Sequence® result screen is displayed.

At the left side of the display the single tests and their statuses in the Auto Sequence® are shown.

In the middle of the display the header of the Auto Sequence® with Short code and description of the Auto Sequence® is displayed. At the top the overall Auto Sequence® result status is displayed. Refer to chapter 5.1.1 *Measurement statuses* for more information.

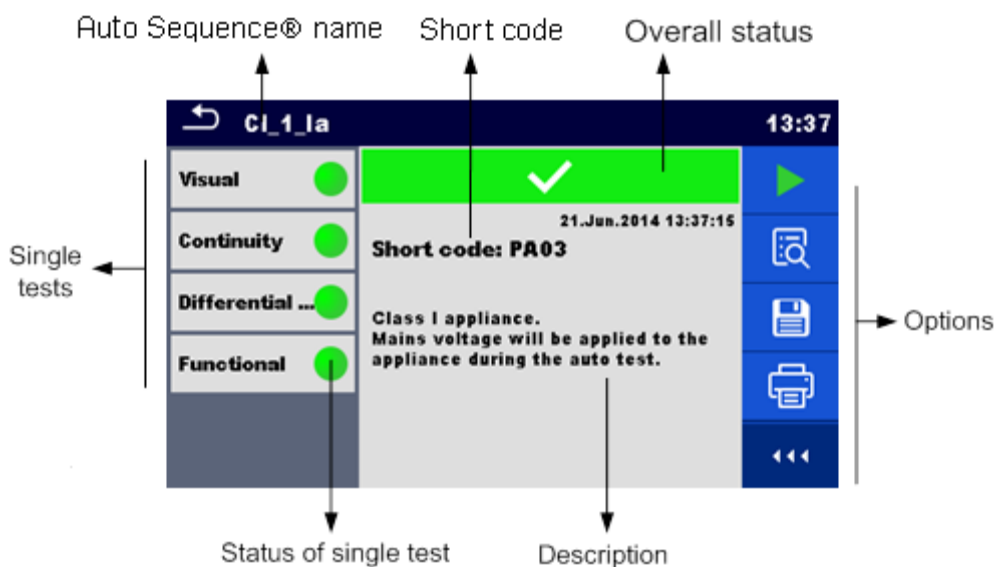


Figure 7.8: Auto Sequence® result screen

Options



Starts a new Auto Sequence®.



View results of individual measurements.

The instrument goes to menu for viewing details of the Auto Sequence®.




Saves the Auto Sequence® results.

A new Auto Sequence® was selected and started from a Structure object in the structure tree:

- The Auto Sequence® result will be saved under the selected Structure object.

A new Auto Sequence® was started from the Auto Sequence® main menu:

- Saving under the last selected Structure object will be offered by default. The user can select another Structure object or create a new Structure object. By pressing  in Memory organizer menu the Auto Sequence result is saved under selected location.

An empty measurement was selected in structure tree and started:

- The result(s) will be added to the Auto Sequence®. The Auto Sequence® will change its overall status from 'empty' to 'finished'.

An already carried out Auto Sequence® was selected in structure tree, viewed and then restarted:

- A new Auto Sequence result will be saved under the selected Structure object.



Print label or goes to Print label menu.

Menu is offered only if additional Label Type setting options are available. For more information refer to chapter *Appendix C - Print labels and write / read RFID / NFC tags*



Print and Save Auto Sequence® results simultaneously.

Option is available if Devices parameter Auto save is set to On print, see chapter **4.8 Devices** for more information.



Write RFID / NFC tag. All data including Auto Sequence® results are written to the RFID/NFC writing device. Refer to *Appendix C - Print labels and write / read RFID / NFC tags* for supported tag types.



Write RFID / NFC tag and Save Auto Sequence® results simultaneously. Option is available if Devices parameter Auto save is set to On write, see chapter **4.8 Devices** for more information.



Adds comment.

The instrument opens keypad for entering a comment to Auto Sequence® result.

Note:

- Options menu content depends on Devices settings menu. If no writing device is set, then 'Print label' and 'Write RFID' icons are hidden. Only one writing device can be set at the same time.

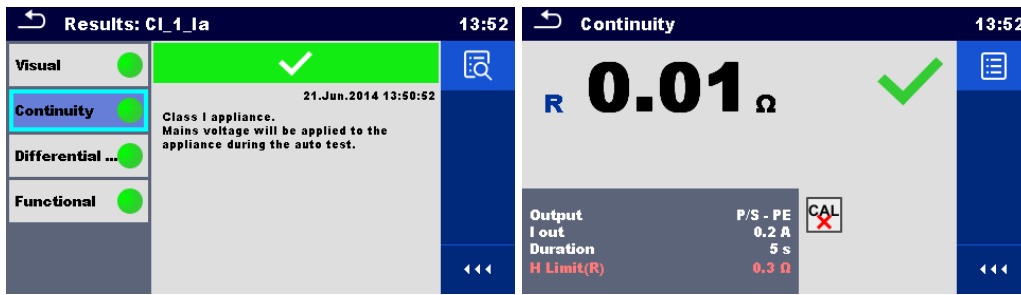


Figure 7.9: Details of menu for viewing details of Auto Sequence® results

Options (menu for viewing details of Auto Sequence® results):



Details of selected single test in Auto Sequence® are displayed.



View parameters and limits of selected single test.



Add comment to selected single test results.

View / edit comment to single test results, when recalled from memory.

7.2.4 Auto Sequence® memory screen

In Auto Sequence® memory screen details of the Auto Sequence® results can be viewed, labels can be printed and a new Auto Sequence® can be restarted.

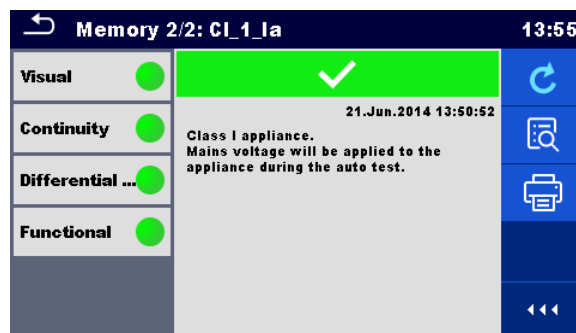


Figure 7.10: Auto Sequence® memory screen

Options:



Retest the Auto Sequence®.

Enters menu for a new Auto Sequence®.



Enters menu for viewing details of the Auto Sequence®. Refer to chapter 7.2.3 *Auto Sequence® result screen* for more information.



Print label or goes to Print label menu.

Menu is offered only if additional Label Type setting options are available. For more information refer to chapter 7.2.5 *Print label menu*.



Write RFID / NFC tag. All data including Auto Sequence® results are written to the RFID / NFC writing device. Refer to *Appendix C - Print labels and write / read RFID / NFC tags* for supported tag types.

Note:

- Options menu content depends on Devices settings menu. If no writing device is set, then 'Print label' and 'Write RFID' icons are hidden. Only one writing device can be set at the same time.

7.2.5 Print label menu

In the Print label menu, the label type to be printed can be set. For more information about supported labels, refer to *Appendix C - Print labels and write / read RFID / NFC tags*.



Figure 7.11: Print label menu

Print label options:

Label type	Type [simple, classic, QR] Simple – data in text format, without barcode Classic – label with barcode (includes Short code and appliance ID) QR – label with QR code (all data, including results)
No. of tags	Tags [1 tag, 2 tags] 1 tag – single tag will be printed 2 tags – two separate labels will be printed (one for appliance and one for the mains cord)

Option:



Print label(s).

8 Maintenance

8.1 Periodic calibration

It is essential that all measuring instruments are regularly calibrated in order for the technical specification listed in this manual to be guaranteed. We recommend an annual calibration.

8.2 Fuses

There are two fuses on the left side panel:

F1, F2: T 16 A / 250 V / (32 × 6,3) mm / 1500 A: intended for instrument protection.

For position of fuses refer to chapter 3.1 *Front panel*.

Warnings!

- › **Switch off the instrument and disconnect all test accessories and mains cord before replacing the fuses.**
- › **Replace blown fuses with the same type as defined in this document.**

8.3 Service

For repairs under or out of warranty please contact your distributor for further information.

Unauthorized person is not allowed to open the OmegaPAT XA instrument. There are no user replaceable parts inside the instrument.

8.4 Cleaning

Use a soft, slightly moistened cloth with soap water or alcohol to clean the surface of OmegaPAT XA instrument. Leave the instrument to dry totally before using it.

Notes:

- › Do not use liquids based on petrol or hydrocarbons!
- › Do not spill cleaning liquid over the instrument!

9 Communications

The instrument can communicate with the Metrel ES Manager PC software. The following action is supported:

- › Saved results and Tree structure from Memory organizer can be downloaded and stored to a PC.
- › Tree structure and Auto Sequences® from Metrel ES Manager PC software can be uploaded to the instrument.

Metrel ES Manager is a PC software running on Windows 7, Windows 8, Windows 8.1 and Windows 10.

There are three communication interfaces available on the instrument: RS-232, USB and Bluetooth. Instrument can also communicate to various external devices (android devices, test adapters, scanners, printers,...).

9.1 USB and RS232 communication with PC

The instrument automatically selects the communication mode according to detected interface. USB interface has priority.

How to establish an USB or RS-232 link:

-
- › RS-232 communication: connect a PC COM port to the instrument PC / PRINTER connector using the RS232 serial communication cable;
-
- › USB communication: connect a PC USB port to the instrument USB connector using the USB interface cable.
-
- › Switch on the PC and the instrument.
-
- › Run the *Metrel ES Manager* software.
-
- › Select communication port (COM port for USB communication is identified as "Measurement Instrument USB VCom Port").
-
- › The instrument is prepared to communicate with the PC.
-

9.2 Bluetooth communication

The internal Bluetooth module enables easy communication via Bluetooth with PC and Android devices.

How to configure a Bluetooth link between instrument and PC

-
- › Switch On the instrument.
-
- › On PC configure a Standard Serial Port to enable communication over Bluetooth link between instrument and PC. Usually no code for pairing the devices is needed.
-
- › Run the *Metrel ES Manager* software.
-
- › Select configured communication port.
-
- › The instrument is prepared to communicate with the PC.
-

How to configure a Bluetooth link between instrument and Android device

- › Switch On the instrument.
- › Some Android applications automatically carry out the setup of a Bluetooth connection. It is preferred to use this option if it exists. This option is supported by Metrel's Android applications.
- › If this option is not supported by the selected Android application then configure a Bluetooth link via Android device's Bluetooth configuration tool. Usually no code for pairing the devices is needed.
- › The instrument and Android device are ready to communicate.

Notes:

- › Sometimes there will be a demand from the PC or Android device to enter the code. Enter code '1234' to correctly configure the Bluetooth link.
- › The name of correctly configured Bluetooth device must consist of the instrument type plus serial number, eg. *MI 3360-122404291*. If the Bluetooth module got another name, the configuration must be repeated.
- › In case of serious troubles with the Bluetooth communication it is possible to reinitialize the internal Bluetooth module. The initialization is carried out during the Initial settings procedure. In case of a successful initialization "INITIALIZING... OK!" is displayed at the end of the procedure. See chapter 4.7.7 *Initial Settings*.
- › Check if there are available Metrel Android applications for this instrument.

9.3 Bluetooth communication with printers and scanners

OmegaPAT XA instrument can communicate with supported Bluetooth printers and scanners. Contact Metrel or your distributor which external devices and functionalities are supported. See Chapter 4.8 *Devices* for details how to set the external Bluetooth device.

9.4 RS232 communication with other external devices

It is possible to communicate with serial scanners and RFID / NFC reader / writer device via the BARCODE serial port and with serial printers via the PC / PRINTER serial port. Contact Metrel or your distributor which external devices and functionalities are supported. See Chapter 4.8 *Devices* for details how to set the external device.

9.5 Connections to test adapters

9.5.1 Active 3 Phase Adapter /Plus (A 1322 / A 1422)

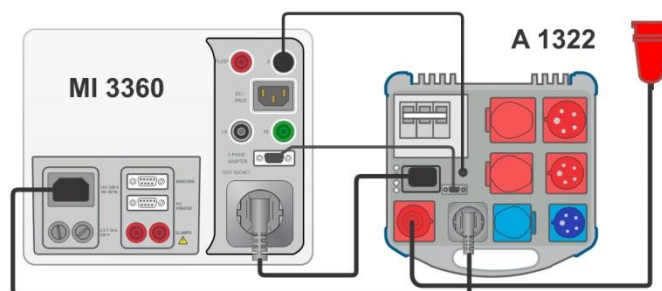


Figure 9.1: Connecting Active 3 Phase Adapter /plus (A 1322 / A 1422)

Notes:

- › See 3-phase adapter user manual for more details.
- › Do not connect other devices than Metrel test adapters to the 3 PHASE ADAPTER connector.

9.5.2 110 V Test Adapter (A 1474)

110 V Adapter (A 1474) is used as interface to connect 110 V appliances to the instrument.



Figure 9.2: Connecting 110 V Test Adapter (A 1474)

Note:

- › Instrument detects the adapter and blocks measurements if mains voltage is too high.

10 Technical specifications

10.1 Continuity // Protective earth resistance

Continuity

	Range	Resolution	Accuracy
R	0.00 Ω ... 19.99 Ω	0.01 Ω	$\pm(2\%$ of reading + 2 D)
	20.0 Ω ... 99.9 Ω	0.1 Ω	$\pm 3\%$ of reading
	100.0 Ω ... 199.9 Ω	0.1 Ω	$\pm 5\%$ of reading
	200 Ω ... 999 Ω	1 Ω	indicative

Operating range (acc. to EN 61557-4)..... 0.08 Ω ... 199.9 Ω
 Test currents..... 0.2 A, 10 A, 25 A
 Current source (at nominal mains voltage, use of standard accessories)
 > 0.2 A at R < 2 Ω
 > 10 A at R < 0.1 Ω at 230 V
 > 25 A into short circuit at 230 V
 Open circuit voltage..... < 9 V a.c.

Test terminals:
 Continuity

R (200 mA)	P/S – PE, Socket PE; Socket PE – IEC PE
R (10 A, 25 A)	P/S – Socket PE; Socket PE – IEC PE

Protective earth resistance

R (200 mA)	P/AP – PE, Socket PE
R (10 A, 25 A)	P/AP – Socket PE

10.2 Insulation Resistance (Riso, Riso-S)

Insulation resistance, Insulation resistance –S (250 V, 500 V)

	Range	Resolution	Accuracy
Riso Riso-S	0.00 M Ω ... 19.99 M Ω	0.01 M Ω	$\pm(3\%$ of reading + 2 D)
	20.0 M Ω ... 99.9 M Ω	0.1 M Ω	$\pm 5\%$ of reading
	100.0 M Ω ... 199.9 M Ω	0.1 M Ω	$\pm 10\%$ of reading

Output voltage

	Range	Resolution	Accuracy
Um	0 V ... 600 V	1 V	$\pm(3\%$ of reading + 2 D)

Operating range (acc. to EN 61557-2).....0.08 M Ω ... 199.9 (999) M Ω
 Nominal voltages Un250 V, 500 V (- 0 %, + 10 %)
 Short circuit currentmax. 2.0 mA

Test terminals:

Riso	LN, Socket LN – PE, Socket PE, P/S
Riso-S	LN, Socket LN – P/S

10.3 Sub-Leakage Current, Substitute Leakage Current - S

Substitute leakage current, Substitute leakage current - S

	Range	Resolution	Accuracy
Isub	0.00 mA ... 1.99 mA	0.01 mA	±(3 % of reading + 3 D)
Isub-S	2.00 mA ... 19.99 mA	0.01 mA	±(5 % of reading)

Operating range (acc. to EN 61557-16)..... 0.02 mA ... 19.99 mA

Open circuit voltage..... 230 V a.c., 110 V a.c.

Current calculated to mains supply voltage (110 V or 230 V) is displayed.

Test terminals:

Isub	LN, Socket LN – PE, Socket PE, P/S
Isub-S	LN, Socket LN – P/S

10.4 Differential Leakage current

Differential leakage current

	Range	Resolution	Accuracy
Idiff	0.000 mA ... 1.999 mA	1 µA	±(3 % of reading + 3 D)
	2.00 mA ... 19.99 mA	0.01 mA	±(5 % of reading)

Power (active)

	Range	Resolution	Accuracy
P	0 W ... 999 W	1 W	±(5 % of reading + 5 D)
	1.00 kW ... 3.70 kW	10 W	± 5 % of reading

Operating range (acc. to EN 61557-16)..... 0.010 mA ... 19.99 mA

Influence of load current..... < 0.02 mA/A

Test terminals:

Idiff	Socket L,N – Socket PE, P/S
P	Socket L – Socket N

10.5 PE leakage current

PE leakage current

	Range	Resolution	Accuracy
Ipe	0.000 mA ... 1.999 mA	1 µA	±(3 % of reading + 3 D)
	2.00 mA ... 19.99 mA	0.01 mA	±(5 % of reading)

Power (active)

	Range	Resolution	Accuracy
P	0 W ... 999 W	1 W	±(5 % of reading + 5 D)
	1.00 kW ... 3.70 kW	10 W	± 5 % of reading

Operating range (acc. to EN 61557-16)..... 0.010 mA ... 19.99 mA

Test terminals:

I _{pe}	Socket L,N – Socket PE
P	Socket L – Socket N

10.6 Touch leakage current

Touch leakage current

	Range	Resolution	Accuracy
I _{pe}	0.000 mA ... 1.999 mA	1 µA	±(3 % of reading + 3 D)
	2.00 mA ... 19.99 mA	0.01 mA	±(5 % of reading)

Power (active)

	Range	Resolution	Accuracy
P	0 W ... 999 W	1 W	±(5 % of reading + 5 D)
	1.00 kW ... 3.70 kW	10 W	± 5 % of reading

Operating range (acc. to EN 61557-16)..... 0.010 mA ... 19.99 mA

Test terminals:

I _{toU}	Socket L,N – P/S
P	Socket L – Socket N

10.7 Power

Power (active)

	Range	Resolution	Accuracy
P	0 W ... 999 W	1 W	±(5 % of reading + 5 D)
	1.00 kW ... 3.70 kW	10 W	± 5 % of reading

Power (apparent)

	Range	Resolution	Accuracy
S	0 VA ... 999 VA	1 VA	±(5 % of reading + 5 D)
	1.00 kVA ... 3.70 kVA	10 VA	± 5 % of reading

Power (reactive)

	Range	Resolution	Accuracy
Q	±(0 VAr ... 999) VAr	1 VAr	±(5 % of reading + 5 D)
	±(1.00 kVAr ... 3.70) kVAr	10 VAr	± 5 % of reading

Power factor

	Range	Resolution	Accuracy
PF	0.00i ... 1.00i 0.00c ... 1.00c	0.01	±(5 % of reading + 5 D)

Total Harmonic Distortion (voltage)

	Range	Resolution	Accuracy
THDU	0.0 % ... 99.9 %	0.1 %	±(5 % of reading + 5 D)

Total Harmonic Distortion (current)

	Range	Resolution	Accuracy
THDI	0.00 A ... 16.00 A	0.01 A	±(3 % of reading + 5 D)

Cosinus Φ

	Range	Resolution	Accuracy
Cos Φ	0.00i ... 1.00i 0.00c ... 1.00c	0.01	±(5 % of reading + 5 D)

Current

	Range	Resolution	Accuracy
I	0.00 A ... 16.00 A	0.01 A	±(3 % of reading + 5 D)

Voltage

	Range	Resolution	Accuracy
U	0.0 V ... 199.9 V	0.1 V	±(3 % of reading + 10 D)
	200 V ... 264 V	1 V	±3 % of reading

Test terminals:

P,S,Q,PF,THDU,THDI, Cos Φ , I, U	Socket L – Socket N
---------------------------------------	---------------------

10.8 Leak's & Power**Power (active)**

	Range	Resolution	Accuracy
P	0 W ... 999 W	1 W	±(5 % of reading + 5 D)
	1.00 kW ... 3.70 kW	10 W	± 5 % of reading

Touch leakage current

	Range	Resolution	Accuracy
I _{toU}	0.000 mA ... 1.999 mA	1 μ A	±(3 % of reading + 3 D)
	2.00 mA ... 19.99 mA	0.01 mA	±(5 % of reading)

Operating range (acc. to EN 61557-16)..... 0.010 mA ... 19.99 mA

Differential leakage current

	Range	Resolution	Accuracy
I _{diff}	0.000 mA ... 1.999 mA	1 μ A	±(3 % of reading + 3 D)
	2.00 mA ... 19.99 mA	0.01 mA	±(5 % of reading)

Operating range (acc. to EN 61557-16)..... 0.010 mA ... 19.99 mA

Influence of load current..... < 0.02 mA/A

Power (apparent)

	Range	Resolution	Accuracy
S	0 VA ... 999 VA	1 VA	±(5 % of reading + 5 D)
	1.00 kVA ... 3.70 kVA	10 VA	± 5 % of reading

Power (reactive)

	Range	Resolution	Accuracy
Q	0 VAr ... 999 VAr	1 VAr	±(5 % of reading + 5 D)
	1.00 kVAr ... 3.70 kVAr	10 VAr	± 5 % of reading

Power factor

	Range	Resolution	Accuracy
PF	0.00i ... 1.00i	0.01	±(5 % of reading + 5 D)
	0.00c ... 1.00c		

Total Harmonic Distortion (voltage)

	Range	Resolution	Accuracy
THDU	0.0 % ... 99.9 %	0.1 %	±(5 % of reading + 5 D)

Total Harmonic Distortion (current)

	Range	Resolution	Accuracy
THDI	0.00 A ... 16.00 A	0.01 A	±(3 % of reading + 5 D)

Cosinus Φ

	Range	Resolution	Accuracy
Cos Φ	0.00i ... 1.00i	0.01	±(5 % of reading + 5 D)
	0.00c ... 1.00c		

Current

	Range	Resolution	Accuracy
I	0.00 A ... 16.00 A	0.01 A	±(3 % of reading + 5 D)

Voltage

	Range	Resolution	Accuracy
U	0.0 V ... 199.9 V	0.1 V	±(3 % of reading + 10 D)
	200 V ... 264 V	1 V	±3 % of reading

Test terminals:

P,S,Q,PF,THDU,THDI, Cos Φ , I, U	Socket L – Socket N
Idiff	Socket L,N – Socket PE, P/S
Itou	Socket L,N – P/S

10.9 PRCD test

Trip-out time

	Range	Resolution	Accuracy
t Δ N	0 ms ... 300 ms (999 ms*) ($\frac{1}{2} \times I_{\Delta N}$)	1 ms	± 3 ms
	0 ms ... 300 ms ($I_{\Delta N}$)	1 ms	± 3 ms
	0 ms ... 40 ms ($5 \times I_{\Delta N}$)	1 ms	± 3 ms

*According to standard AS/NZS 3017

Trip out-current

	Range	Resolution	Accuracy
I Δ	$0.2 \times I_{\Delta N} \dots 2.2 \times I_{\Delta N}$	$0.05 \times I_{\Delta N}$	$\pm 0.1 \times I_{\Delta N}$

Test current type:.....sine-wave (AC), pulsed (A,F), smooth DC (B,B+)

Test currents (I Δ N): 10 mA, 15 mA, 30 mA

.....100 mA and 300 mA with A1322, A1422

Test current size (PRCD standard is AS/NZS 3017)..... $\pm 5\%$

Test current size (general).....-0/+10%

Test terminals:

t Δ N, I Δ	Socket – IEC
--------------------------	--------------

10.10 RCD test

Trip-out time

	Range	Resolution	Accuracy
t Δ N	0 ms ... 300 ms (999 ms*) ($\frac{1}{2} \times I_{\Delta N}$)	1 ms	± 3 ms
	0 ms ... 300 ms ($I_{\Delta N}$)	1 ms	± 3 ms
	0 ms ... 40 ms ($5 \times I_{\Delta N}$)	1 ms	± 3 ms

*According to standard AS/NZS 3017

Trip out-current

	Range	Resolution	Accuracy
I Δ	$0.2 \times I_{\Delta N} \dots 2.2 \times I_{\Delta N}$	$0.05 \times I_{\Delta N}$	$\pm 0.1 \times I_{\Delta N}$

Contact voltage

	Range	Resolution	Accuracy
Uc	0.0 V ... 19.9 V	0.1 V	(-0 % / +15 %) of reading ± 10 D
	20.0 V ... 99.9 V	0.1 V	(-0 % / +15 %) of reading

Test current type:.....sine-wave (AC), pulsed (A,F), smooth DC (B,B+)

Test currents (I Δ N): 10 mA, 15 mA, 30 mA

Test current size (RCD standard is AS/NZS AS/NZS)..... $\pm 5\%$

Test current size (EN 61008/EN 61009).....-0/+10%

Test terminals:

t Δ N, I Δ	Mains Socket
--------------------------	--------------

10.11 PE conductor (PRCD)

PE conductor (Type = 2 pole, 3 pole, S(3 pole))

	Range	Resolution	Accuracy
R	0.00 Ω ... 19.99 Ω	0.01 Ω	±(2 % of reading + 2 D)
	20.0 Ω ... 99.9 Ω	0.1 Ω	± 3 % of reading
	100.0 Ω ... 199.9 Ω	0.1 Ω	± 5 % of reading
	200 Ω ... 999 Ω	1 Ω	indicative

Operating range (acc. to EN 61557-4)..... 0.08 Ω ... 199.9 Ω
 Current source (at nominal mains voltage, use of standard accessories)
 > 0.2 A at R < 2 Ω
 Open circuit voltage..... < 9 V a.c.

Test terminals:

R	Socket PE – IEC PE
---	--------------------

PE conductor (Type = K/ Di (varistor))

Test principle:
 A voltage is applied between PE connections of the PRCD-K. There is a ‘PASS’ if PRCD trips.

Open circuit voltage..... 24 V
 Output resistance..... 220 Ω ± 10 % (I_{ΔN} = 30 mA), 620 Ω ± 10 % (I_{ΔN} = 10 mA)

Test terminals:

Result	Socket – IEC
--------	--------------

10.12 Open conductor (PRCD)

Test principle:
 Mains voltage is applied to the mains test socket. Disconnection of the L, N and PE connections is performed inside the instrument. There is a ‘PASS’ if the PRCD trips.

Test terminals:

L open, N open, PE open	Socket – IEC
-------------------------	--------------

10.13 PRCD PE probe test

Test principle:
 Mains voltage is applied to the mains test socket. A safe voltage sufficiently high to activate the protection circuit in the PRCD is applied to the P/S terminal.

Test voltage (active) > 100 V a.c.
 Maximal current < 1 mA

Test terminals:

Result (manual)	Socket, P/S
Result (auto)	Socket – IEC, P/S

10.14 Polarity

Test voltage (normal)..... < 50 V
 Test voltage (active)..... mains voltage
 Power consumption of tested device during the active test.....< 25 VA

Test terminals:

Result (normal, active)	Socket – IEC
-------------------------	--------------

10.15 Clamp current

True RMS current using 1000:1 current clamp

	Range	Resolution	Accuracy
I Idiff Ipe	0.10 mA ... 9.99 mA	0.01 mA	±(5 % of reading + 10 digits)
	10.0 mA ... 99.9 mA	0.1 mA	±(5 % of reading + 5 digits)
	100 mA ... 999 mA	1 mA	±(5 % of reading + 5 digits)
	1.00 A ... 9.99 A	0.01 A	±(5 % of reading + 5 digits)
	10.0 A ... 24.9 A	0.1 A	±(5 % of reading + 5 digits)

Accuracy of current transformer is not considered.
 Frequency range of current clamp is not considered.

Test terminals:

I, Idiff, Ipe	CLAMPS terminals
---------------	------------------

10.16 Flash test

Current a.c. (apparent)

	Range	Resolution	Accuracy
I	0.00 mA ... 2.50 mA	0.01 mA	±(5 % of reading + 5 D)

Open circuit test voltage 1500 V, 3000 V (-0/+5%) at supply voltage 115 V, 230 V
 Short circuit current.....< 3.5 mA
 Output resistance: 480 kΩ@1500 V, 960 kΩ@3000 V

Test terminals:

I (1500 V)	Socket LN – Socket PE
I (3000 V)	Socket LN – FLASH

10.17 Insulation resistance Riso (welding equipment)

Riso

	Range	Resolution	Accuracy
Riso	0.00 MΩ ... 19.99 MΩ	0.01 MΩ	±(3 % of reading + 2 D)
	20.0 MΩ ... 99.9 MΩ	0.1 MΩ	± 5 % of reading
	100.0 MΩ ... 199.9 MΩ	0.1 MΩ	± 10 % of reading

Output voltage

	Range	Resolution	Accuracy
Um	0 V ... 600 V	1 V	±(3 % of reading + 2 D)

Operating range (acc. to EN 61557-2).....0.08 MΩ ... 199.9 (999) MΩ

Nominal voltages Un500 V (- 0 %, + 10 %)

Short circuit currentmax. 2.0 mA

Test terminals:

Riso LN-W	A 1422: Socket L1 L2 L3 N (16A-5p, 32A-5p or 16A-3p) – W1 W2
Riso W-PE	A 1422: Socket PE (16A-5p, 32A-5p or 16A-3p) – W1 W2
Riso LN-PE	A 1422: Socket L1 L2 L3 N (16A-5p, 32A-5p or 16A-3p) – Socket PE (16A-5p, 32A-5p or 16A-3p)
Riso LN (Class II) - P	A 1422: Socket L1 L2 L3 N (16A-5p, 32A-5p or 16A-3p) – MI 3360: P/S

10.18 Welding Circuit leakage (Ileak W-PE)

Refer to chapter *Technical specifications* in 3-phase adapter instrument user manual.

10.19 Primary Leakage (I diff)

Refer to chapter *Technical specifications* in 3-phase adapter instrument user manual.

10.20 No-load voltage

Refer to chapter *Technical specifications* in 3-phase adapter instrument user manual.

10.21 Insulation Resistance (medical equipment)

Riso

	Range	Resolution	Accuracy
Riso	0.00 M Ω ... 19.99 M Ω	0.01 M Ω	$\pm(3\%$ of reading + 2 D)
	20.0 M Ω ... 199.9 M Ω	0.1 M Ω	$\pm 5\%$ of reading

Output voltage

	Range	Resolution	Accuracy
Um	0 V ... 600 V	1 V	$\pm(3\%$ of reading + 2 D)

Operating range (acc. to EN 61557-2).....0.08 M Ω ... 199.9 (999) M Ω

Nominal voltages Un500 V (- 0 %, + 10 %)

Short circuit currentmax. 2.0 mA

Test terminals:

Riso (LN-PE)	LN, Socket LN – PE, Socket PE
Riso (LN-P/S)	LN, Socket LN – P/S
Riso (LN-AP)	LN, Socket LN – P/AP
Riso (PE-AP)	PE, Socket PE – P/AP

10.22 Equipment leakage

Equipment leakage current (direct, differential, alternative)

	Range	Resolution	Accuracy
Ieq	0.000 mA ... 1.999 mA	1 μ A	$\pm(3\%$ of reading + 3 D)
	2.00 mA ... 19.99 mA	0.01 mA	$\pm(5\%$ of reading)

Ulpe (direct, differential, alternative)

	Range	Resolution	Accuracy
Ulpe	0 V ... 299 V	1 V	$\pm(2\%$ of reading + 2 D)

Power (direct, differential)

	Range	Resolution	Accuracy
P	0 W ... 999 W	1 W	$\pm(5\%$ of reading + 5 D)
	1.00 kW ... 3.70 kW	10 W	$\pm 5\%$ of reading

Operating range direct and differential method (acc. to EN 61557-16).....0.010 mA ... 19.99 mA

Operating range alternative method (acc. to EN 61557-16).....0.020 mA ... 19.99 mA

Influence of load current (differential method)< 0.02 mA/A

Test terminals:

Ieq (alternative)	LN, Socket LN – PE, Socket PE, P/S, P/AP
Ieq (direct, differential)	Socket L,N – PE, Socket PE, P/S, P/AP
Ulpe	Socket L – Socket PE
P (direct, differential)	Socket L – Socket N

10.23 Applied Part leakage

Applied Part leakage current (direct, alternative)

	Range	Resolution	Accuracy
Iap	0.000 mA ... 1.999 mA	1 μ A	$\pm(3\%$ of reading + 3 D)
	2.00 mA ... 19.99 mA	0.01 mA	$\pm(5\%$ of reading)

Uap (direct, alternative)

	Range	Resolution	Accuracy
Uap	0 V ... 299 V	1 V	$\pm(2\%$ of reading + 2 D)

Power (direct)

	Range	Resolution	Accuracy
P	0 W ... 999 W	1 W	$\pm(5\%$ of reading + 5 D)
	1.00 kW ... 3.70 kW	10 W	$\pm 5\%$ of reading

Operating range direct method (acc. to EN 61557-16).....0.010 mA ... 19.99 mA

Operating range alternative method (acc. to EN 61557-16).....0.020 mA ... 19.99 mA

Test terminals:

Iap (alternative)	Socket LNPE, PE – P/AP
Iap (direct)	Socket L,N,PE, PE – P/AP
Uap	Socket PE, PE – P/AP
P	Socket L – Socket N

10.24 Touch current (medical equipment)

Touch current

	Range	Resolution	Accuracy
Itou	0.000 mA ... 1.999 mA	1 μ A	$\pm(3\%$ of reading + 3 D)
	2.00 mA ... 19.99 mA	0.01 mA	$\pm(5\%$ of reading)

Ulpe (direct)

	Range	Resolution	Accuracy
Ulpe	0 V ... 299 V	1 V	$\pm(2\%$ of reading + 2 D)

Power (direct)

	Range	Resolution	Accuracy
P	0 W ... 999 W	1 W	$\pm(5\%$ of reading + 5 D)
	1.00 kW ... 3.70 kW	10 W	$\pm 5\%$ of reading

Operating range (acc. to EN 61557-16)..... 0.010 mA ... 19.99 mA

Test terminals

Itou	Socket L,N – P/S
Ulpe	Socket L – Socket PE
P	Socket L – Socket N

10.25 General data

Mains supply

Supply voltage, frequency	110 V / 230 V AC, 50 Hz / 60 Hz
Supply voltage tolerance	±10 %
Max. power consumption.....	300 VA (without load on test socket)
Max. load.....	10 A continuous, 16 A short duration, 1.5 kW motor
Mains supply overvoltage category	CAT II / 300V
Altitude	≤ 2000 m

Measuring categories

Instrument:.....	Cat II / 300 V
Test socket:.....	Cat II / 300 V
Plug test cable:	Cat II / 300 V
Altitude	≤ 2000 m

Protection classifications

Power supply.....	Class I, mains supply, Class II, only battery supply
Pollution degree.....	2
Degree of protection	IP 40
.....	IP 20 (mains test socket)
Case.....	Shock proof plastic / portable
Display	Colour TFT display, 4.3 inch, 480 x 272 pixels
Touch screen	Capacitive

Communication

Memory	depends on microSD card size
RS232 interfaces	2
USB 2.0.....	Standard USB Type B
Bluetooth.....	Class 2

Dimensions (w×h×d):.....	31 cm × 13 cm × 25 cm
Weight.....	6.1 kg

Reference conditions

Reference temperature range:	15 °C ... 35 °C
Reference humidity range:	35 % ... 65 % RH

Operation conditions

Working temperature range:.....	0 °C ... +40 °C
Maximum relative humidity:.....	85 % RH (0 °C ... 40 °C), non-condensing

Storage conditions

Temperature range:.....	-10 °C ... +60 °C
Maximum relative humidity:.....	90 % RH (-10 °C ... +40 °C)
.....	80 % RH (40 °C ... 60 °C)












Accuracies apply for 1 year in reference conditions. Temperature coefficient outside these limits is 0.2 % of measured value per °C plus 1 digit, otherwise noted.

Fuses

2 x T 16 A / 250 V, 32 mm × 6.3 mm / 1500 A

Appendix A Structure objects in OmegaPAT XA

Structure elements used in Memory Organizer are instrument's Profile dependent.

Symbol	Default name	Description
	Node	Node
	Project	Project
	Location	Location
	Client	Client
	Appliance	Appliance (basic description)
	Appliance FD	Appliance (full description)
	Medical device	Medical device (basic description)
	Medical device FD	Medical device (full description)
	Welding device	Welding device (basic description)
	Welding device FD	Welding device (full description)
	Element	Universal element

Appendix B Profile Notes

There are no specific profile notes for OmegaPAT XA MI 3360.

Appendix C Print labels and write / read RFID / NFC tags

The instrument supports different printers, label size forms and two tag formats (PAT and Generic); listed parameters setting is described in chapter 4.8 *Devices*. By setting the printer, label size forms and tag formats are limited.

Tag content can be presented as text only or arranged as text area and machine-readable code area – barcode or QR code – in addition.

The instrument supports RFID / NFC reader / writer device; tag type supported is NTAG216.

Please check with Metrel or distributor which printers and labels are supported in your OmegaPAT XA instrument.

C.1 PAT tag format

It is intended for tagging of individual appliance with Auto Sequence® test data. To start printing, Auto Sequence® should be finished and saved or reopened from memory structure. When required, printing of two labels of the same test can be set.

Available tag data presented in text area are:

- › Auto Sequence® short Test code
- › Appliance ID
- › Appliance name
- › Test date
- › Retest date
- › Auto Sequence® test status
- › User name (who currently performed test or who performed saved test, if printed from memory)

Available tag data presented in machine-readable area are:

- › Auto Sequence® short Test code
- › Appliance ID
- › Appliance name
- › Test date
- › Test period (from appliance description)
- › Appliance location (from appliance description)
- › Auto Sequence® test status
- › User name (who currently performed test or who performed saved test, if printed from memory)
- › Auto Sequence® measurements results

Actual tag content depends on label type selection, when printing. Content of 1st and 2nd label is also adopted, when 2-label printing is selected.

Following tables describe tag content arrangement and its data for supported form sizes and chosen label type.

Label type	Form size W x H (mm)	Tag content arrangement	Data 1st label	Data 2nd label
Classic	50 x 25.5	Barcode	Test code, appliance ID	Appliance ID
		Text	Test code, appliance ID, test or retest date, status, user	Appliance ID, test or retest date, status, user
QR		QR	Test code, appliance ID, appliance name, test date, test period, location, user, status, measurement results.	Appliance ID, appliance name, test date, test period, location, user, status
		Text	Test code, appliance ID, appliance name, test or retest date, status, user	Appliance ID, appliance name, test or retest date, status, user
Simple		Text	Appliance ID, appliance name, status, test or retest date, user	

Label type	Form size W x H (mm)	Tag content arrangement	Data 1st label	Data 2nd label
Classic L	43 x 99	Barcode	Test code, appliance ID	Appliance ID
		Text	Test code, appliance ID, test and retest date, status, user	Appliance ID, test and retest date, status, user
QR L		QR	Test code, appliance ID, appliance name, test date, test period, location, user, status, measurement results.	Appliance ID, appliance name, test date, test period, location, user, status
		Text	Test code, appliance ID, appliance name, test and retest date, status, user	Appliance ID, appliance name, test and retest date, status, user

Label type	Size W x H (mm)	Tag content arrangement	Data 1st label	Data 2nd label
Classic L (inverted)	100 x 50	Barcode	Test code, appliance ID	Appliance ID
		Text	Test code, appliance ID, test and retest date, status, user	Appliance ID, test and retest date, status, user
QR L (inverted)		QR	Test code, appliance ID, appliance name, test date, test period, location, user, status, measurement results.	Appliance ID, appliance name, test date, test period, location, user, status
		Text	Test code, appliance ID, appliance name, test and retest date, status, user	Appliance ID, appliance name, test and retest date, status, user

Notes:

- 2nd label is intended to mark supply cords.
- Data not available will not be printed on the label.

- › Test or Retest date: is set in the General Settings => Devices => Writing devices menu.
- › If Auto Sequence® was modified, its short code is marked with asterisk (*).

Following table describes data content written on RFID / NFC tag.

RFID / NFC tag type	Data
NTAG216	Test code, appliance ID, appliance name, test date, test period, location, user, status, measurement results.

C.2 Generic tag format

It is intended for tagging structure objects (element, appliance, equipment), which could be tested and their location under parent structure object is important. Label printing can be started from selected structure object (element, appliance, equipment), even if no Auto Sequence® is associated with it, or from finished Auto Sequence® saved under it.

Tag data presented in text area are:

- › Parent structure object ID (name) (← Object_name)
- › Auto Sequence® short test code (if printing from Auto Sequence®; if printing from object field is omitted)
- › Object ID (name)
- › Test date (|→ DD.MM.YYYY) or Retest date (→| DD.MM.YYYY), which one is selected in General Settings => Devices => Writing devices menu
- › Status (printing from object: overall status of all tests appended to the object or sub-structure objects; printing from Auto Sequence®: its status)
- › User name (Printing from Auto Sequence: user who performed test; printing from object: current signed-in user)

Tag data presented in machine-readable area are:

- › Parent structure object ID (name)
- › Auto Sequence® short test code (if printing from Auto Sequence®; if printing from object field is omitted)
- › Object ID (name)
- › Test date
- › Test period (from appliance description)
- › Auto Sequence® status (field is omitted, if not printing from Auto Sequence®)
- › Object status (overall status of all tests appended to the object or sub-structure objects)
- › User name (Printing from Auto Sequence®: user who performed test; printing from object: current signed-in user)

Following table describes tag content arrangement and its data for supported label form size.

Form size W x H (mm)	Tag content arrangement	Data
50 x 25.5	Text	Parent object name, Test code, Object ID, test or retest date, status, user
	QR	Parent object name, Test code, Object ID, test date, test period, Auto Sequence® status, Object status, user.

Notes:

- › Data not available will not be printed on the label.
- › Object without appended Auto Sequence® test has no status!
- › If Auto Sequence® was modified, its short code is marked with asterisk (*).
- › Object status depends on all measurements (Auto Sequences® or Single tests) appended to the object or sub-structure objects, see chapter 5.1.2.1 *Measurement status indication under the Structure object* for details.

Following table describes data content written on RFID / NFC tag.

RFID / NFC tag type	Data
NTAG216	Parent object name, Test code, Object ID, test date, test period, Auto Sequence® status, Object status, user.

Appendix D Default list of Auto Sequences®

Default list of Auto Sequences® for MI 3360 OmegaPAT XA instrument is available on Metrel home page: <http://www.metrel.si>

Appendix E Programming of Auto Sequences® on Metrel ES Manager

The Auto Sequence® editor is a part of the Metrel ES Manager software. In Auto Sequence® editor Auto Sequence® can be pre-programmed and organized in groups, before uploaded to the instrument.

E.1 Auto Sequence® Editor workspace

To enter Auto Sequence® Editor's workspace, select **Auto Sequence® Editor** in Home Tab of Metrel ES Manager PC SW. Auto Sequence® Editor workspace is divided in four main areas. On the left side **1**, structure of selected group of Auto Sequence® is displayed. In the middle part of the workspace **2**, the elements of the selected Auto Sequence® are shown. On the right side, list of available Single tests **3** and list of Flow commands **4** are shown. Single test area contains three tabs, Measurements, Inspections and Custom Inspections tab. Custom Inspections and their tasks are programmed by user.

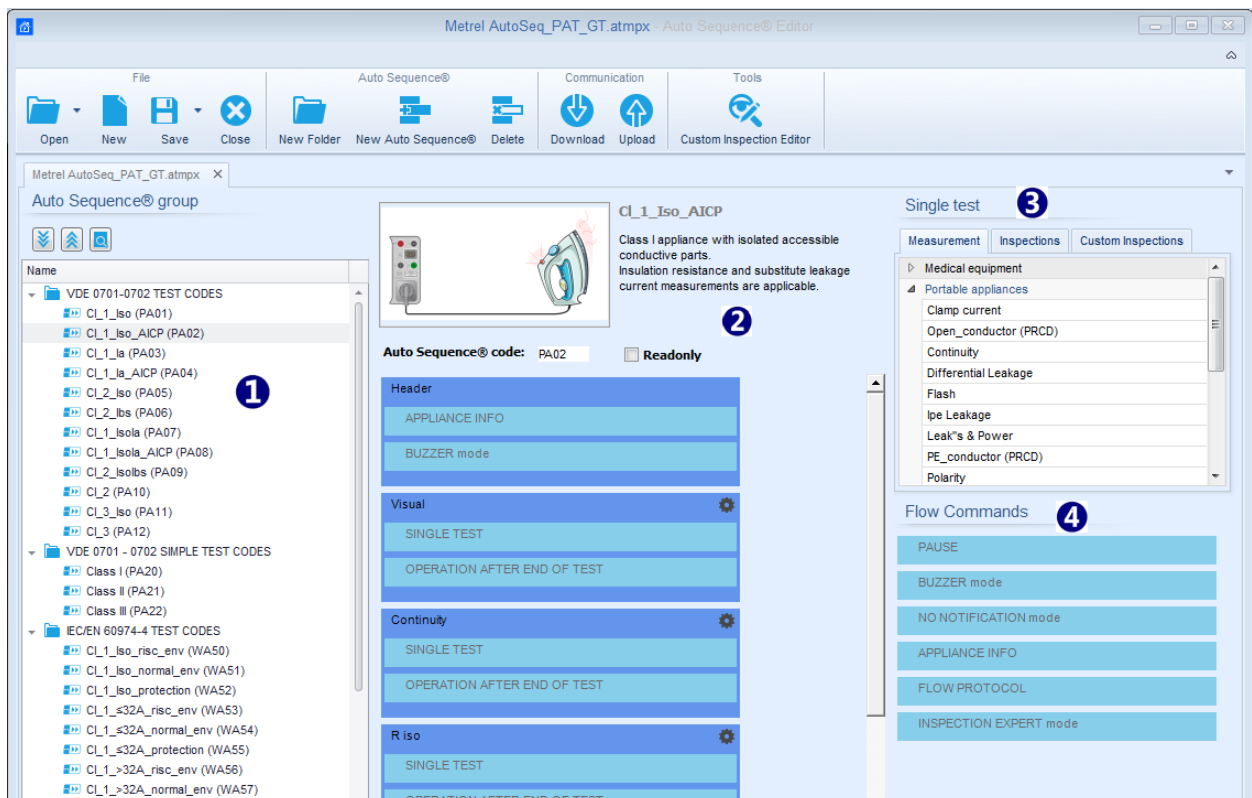


Figure E.1: Auto Sequence® Editor workspace

An Auto Sequence® **2** begins with Name, Description and Image, followed by the first step (Header), one or more measuring steps and ends with the last step (Result). By inserting

appropriate Single tests (measurements, inspections and custom inspections) **3** and Flow commands **4** and setting their parameters, arbitrary Auto Sequences® can be created.

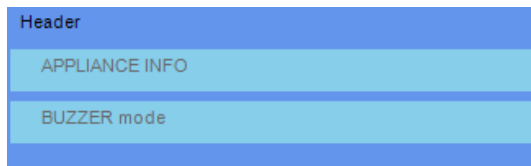


Figure E.2: Example of an Auto Sequence® header

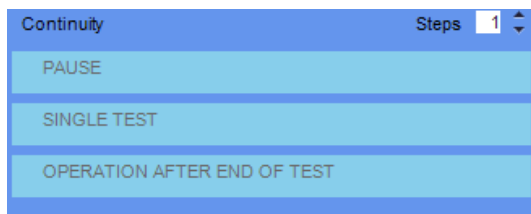


Figure E.3: Example of a measurement step

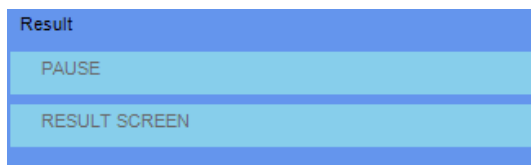


Figure E.4: Example of an Auto Sequence® result

E.2 Managing groups of Auto Sequences®

The Auto Sequences® can be divided into different user defined groups of Auto Sequences®. Each group of Auto Sequences® is stored in a file. More files can be opened simultaneously in Auto Sequence® editor.

Within Group of Auto Sequences®, tree structure can be organized, with folders / subfolders containing Auto Sequences®. The tree structure of currently active Group of Auto Sequences® is displayed on the left side of the Auto Sequence® editor workspace, see *Figure E.5*.

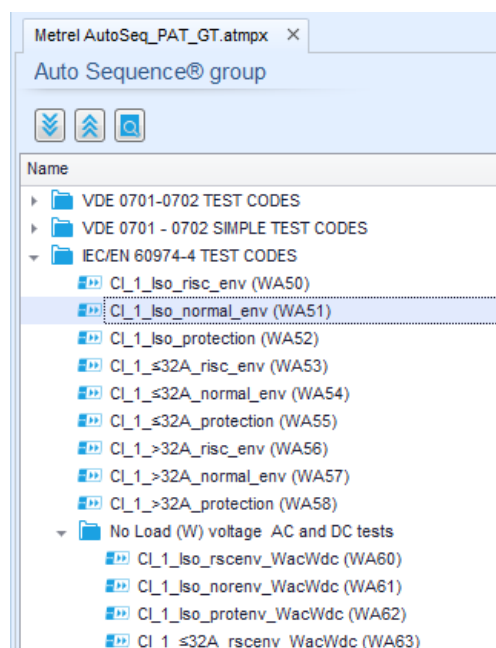









Figure E.5: Group of Auto Sequences® tree organization

Operation options on Group of Auto Sequences® are available from menu bar at the top of Auto Sequence® Editor workspace.




File operation options:

	Opens a file (Group of Auto Sequences®).
	Creates a new file (Group of Auto Sequences®).
	Saves / Saves as the opened Group of Auto Sequences® to a file.
	Closes the file (Group of Auto Sequences®).





Group of Auto Sequences® view options:

	Expand all folders / subfolders / Auto Sequences®.
	Collapse all folders / subfolders / Auto Sequences®.
	Toggle between Search by name within Auto Sequence® group and normal view. See chapter <i>E.2.2 Search within selected Auto Sequence® group</i> for details.



Group of Auto Sequences® operation options (also available by right clicking on Folder or Auto Sequence®):

	Adds a new folder / subfolder to the group
	Adds a new Auto Sequence® to the group.
	Deletes: <ul style="list-style-type: none"> - the selected Auto Sequence® - the selected folder with all subfolders and Auto Sequences®



Right click on the selected Auto Sequence® or Folder opens menu with additional possibilities:

	Auto Sequence®: Edit Name, Description and Image (see <i>Figure E.6</i>). Folder: Edit folder name
	Auto Sequence®: Copy to clipboard Folder: Copy to clipboard including subfolders and Auto Sequences®
	Auto Sequence®: Paste it to selected location Folder: Paste it to selected location
	Auto Sequence®: Creates shortcut to selected Auto Sequence®

Double click on the object name allows it name edit:

DOUBLE CLICK	<p>Auto Sequence® name: Edit Auto Sequence® name</p> <p> New Auto Sequence®</p> <p>Folder name: Edit folder name</p> <p> Portable Handheld Equipment</p>
--------------	--

Drag and drop of the selected Auto Sequence® or Folder / Subfolder moves it to a new location:

DRAG & DROP	<p>“Drag and drop” functionality is equivalent to “cut” and “paste” in a single move.</p> <p> move to folder</p> <p> insert</p>
-------------	---



E.2.1 Auto Sequence® Name, Description and Image editing

When EDIT function is selected on Auto Sequence®, menu for editing presented on *Figure E.6* appear on the screen. Editing options are:

Name: Edit or change the name of Auto Sequence®.

Description: Any text for additional description of Auto Sequence® can be entered.

Image: Image presenting Auto sequence® measuring arrangement can be entered or deleted.

	Enters menu for browsing to Image location.
	Deletes the Image from Auto Sequence®.

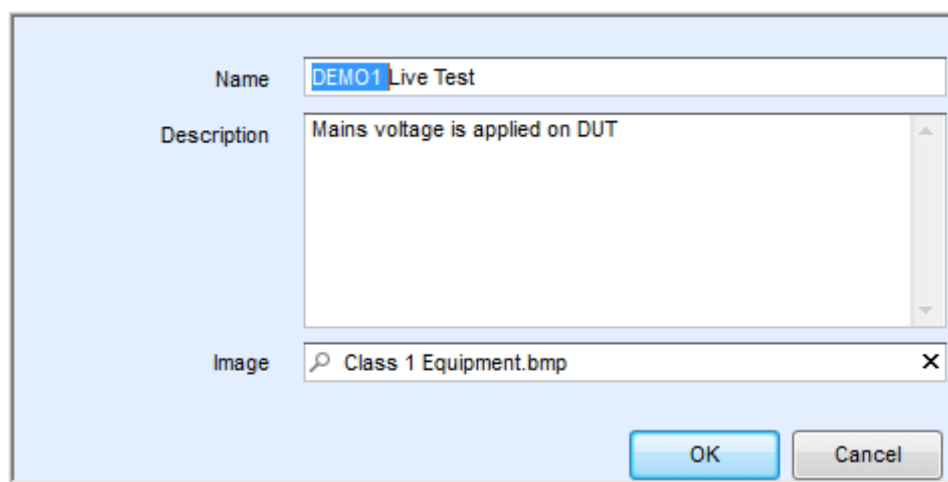



Figure E.6: Editing the Auto Sequence® Name, Description and Image

E.2.2 Search within selected Auto Sequence® group

When  function is selected, Search menu as presented on *Figure E.7* appear on the screen. By entering the text into search box, found results are automatically highlighted with yellow background. Search functionality is implemented in Folders, Subfolders and Auto Sequences® of selected Auto Sequence® Group. Search functionality is case sensitive. Search text can be cleared by selecting the Clear button.

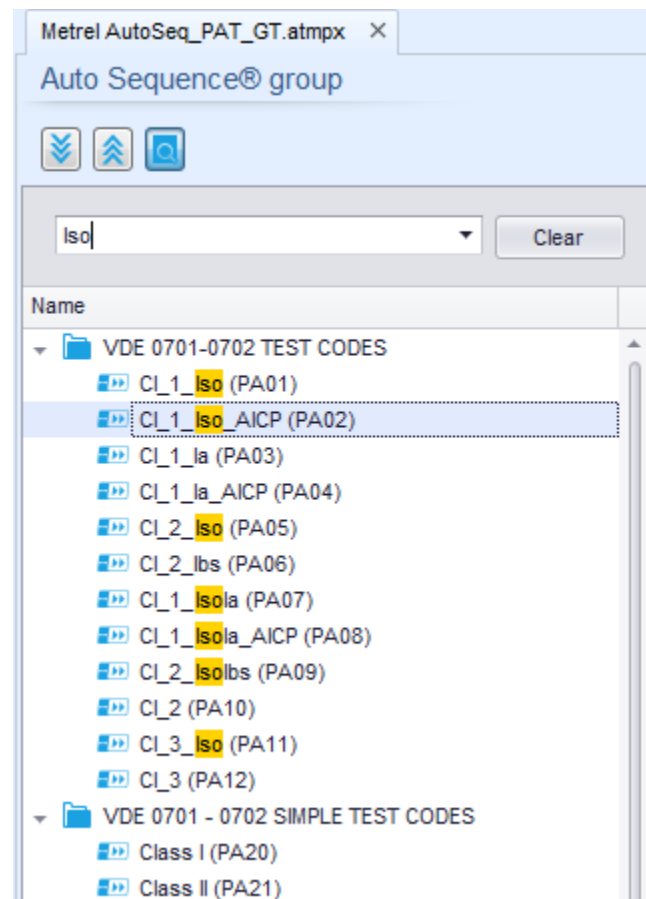


Figure E.7: Example of Search result within Auto Sequence® group

E.3 Elements of an Auto Sequence®

E.3.1 Auto Sequence® steps

There are three kinds of Auto Sequence® steps.

Header

The Header step is empty by default.

Flow commands can be added to the Header step.

Measurement step

The Measurement step contains a Single test and the Operation after end of test flow command by default. Other Flow commands can also be added to the Measurement step.

Result

The Result step contains the Result screen flow command by default. Other Flow commands can also be added to the Result step.

E.3.2 Single tests

Single tests are the same as in Metrel ES Manager Measurement menu.

Limits and parameters of the measurements can be set. Results and sub-results can't be set.

E.3.3 Flow commands

Flow commands are used to control the flow of measurements. Refer to chapter *E.5 Description of flow commands* for more information.



E.3.4 Number of measurement steps


Often the same measurement step has to be performed on multiple points on the device under test. It is possible to set how many times a Measurement step will be repeated. All carried out individual Single test results are stored in the Auto Sequence® result as if they were programmed as independent measuring steps.

E.4 Creating / modifying an Auto Sequence®

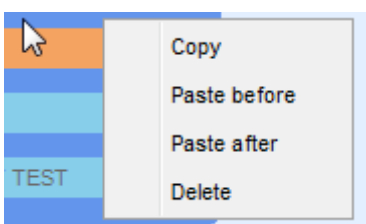
If creating a new Auto Sequence® from scratch, the first step (Header) and the last step (Result) are offered by default. Measurement steps are inserted by the user.

Options:

Adding a measurement step	By double clicking on a Single test a new measurement step will appear as the last of measurement steps. It can also be dragged and dropped on the appropriate position in the Auto Sequence®.
Adding flow commands	Selected flow command can be dragged from the list of Flow commands and dropped on the appropriate place in any Auto Sequence® step.
Changing position of flow command within measurement step	By a click on an element and use of  and  keys.

Viewing / changing parameters of flow commands or single tests.	By a double click on the element.
Setting number of measurement step repetitions	By setting a number in the  field.

Right click on the selected measurement step / flow command:

	<p>Copy – Paste before A measurement step / flow command can be copied and pasted above selected location on the same or on another Auto Sequence®.</p> <p>Copy – Paste after A measurement step / flow command can be copied and pasted under selected location on the same or on another Auto Sequence®.</p> <p>Delete Deletes the selected measurement step / flow command.</p>
---	---


E.5 Description of flow commands

Double click on inserted Flow Command opens menu window, where text or picture can be entered, external commands can be activated and parameters can be set. Flow commands Operation after end of test and Results screen are entered by default, others are user selectable from Flow Commands menu.

Pause

A Pause command with text message or picture can be inserted anywhere in the measuring steps. Warning icon can be set alone or added to text message. Arbitrary text message can be entered in prepared field Text of menu window.

Parameters:

Pause type	Show text and/or warning (<input checked="" type="checkbox"/> check to show warning icon) Show picture ( browse for image path)
Duration	Number in seconds, infinite (no entry)

Buzzer mode

Passed or failed measurement is indicated with beeps.

- › Pass – double beep after the test
- › Fail – long beep after the test

Beep happens right after single test measurement.

Parameters

State	On – enables Buzzer mode Off – disables Buzzer mode
-------	--

No notifications mode

Instrument skips pre-test warnings (see chapter 4.5 *Symbols and messages* for more information).

Parameters

State	On – enables No notifications mode Off – disables No notifications mode
-------	--

Appliance info

Instrument enables to automatically select the appliance type and add the Appliance ID, Appliance name and Retest period to the Auto Sequence®.

Parameters

Repeat Setting	Repeat:	The same Appliance ID will be offered each time if the same Auto Sequence® is carried out successively in a loop.
	Increment:	A four digit number will be added to the Appliance ID and incremented each time if the same Auto Sequence® is carried out successively in a loop.
Appliance type	Selects the type of the appliance (Appliance, Appliance_FD, Medical Equip., Medical Equip. FD, Welding Equip., Welding Equip. FD)	
Default Appliance ID	Enter default Appliance ID	
Appliance name	Enter Appliance name. Options: <input checked="" type="checkbox"/> Editable – allows Appliance name to be modified while running Auto Sequence®. Menu with a list of Appliance names and possibility to enter custom Appliance name is offered within the test. <input type="checkbox"/> Not editable – Default Appliance name is used. Appliance name cannot be modified while running Auto Sequence®.	
Retest period	Retest period in months. Options: <input checked="" type="checkbox"/> Editable – allows Retest period to be modified while running Auto Sequence®. Numeric keypad for entering custom Retest period is offered within the test. <input type="checkbox"/> Not editable – Default Retest period is used. Retest period cannot be modified while running Auto Sequence®.	

Note

- This flow command is active only if Auto Sequence® is started from the Auto Sequence® Main menu.

Inspection Expert mode

If Inspection Expert mode flow command is set, the Visual inspection screen and Functional inspection screen within Auto Sequence® are displayed for 1 second and an overall PASS is automatically applied at the end of test. In between, the automatic procedure can be stopped and statuses can be applied manually.

Inspection Expert mode is disabled by default.

Parameters

State	On – enables automatic settings of tickers in Visual and Functional tests. Off – disables automatic settings of tickers in Visual and Functional tests.
-------	--

Operation after end of test

This flow command controls the proceeding of the Auto Sequence® in regard to the measurement results.

Parameters

Operation after end of test – pass – fail – no status	The operation can be individually set for the case the measurement passed, failed or ended without a status.	
	Manual:	The test sequence stops and waits for appropriate command (RUN key, external command...) to proceed.
	Auto:	The test sequence automatically proceeds.

Result screen

This flow commands control the proceeding after the Auto Sequence® has ended.

Parameters


<input checked="" type="checkbox"/> Auto Save	Auto Sequence® results are stored in the momentary workspace. A new Node with the date and time will be created. Under the Node Auto Sequence® results or (if Appliance info flow command is set) a new appliance and Auto Sequence® results will be stored. Up to 100 Auto Sequence® results or appliances can be automatically stored under the same node. If more results / appliances are available, they are split to multiple nodes. Local Save Flow setting is disabled by default. Note <ul style="list-style-type: none"> · This flow command is active only if Auto Sequence® is started from the Auto Sequence® Main menu (not from the Memory organizer).
<input checked="" type="checkbox"/> Auto Print	Auto Sequence® results are automatically printed. If multiple print options are possible Print label menu is opened before printing, Note <ul style="list-style-type: none"> · This flow command is active only if Auto Sequence® is started from the Auto Sequence® Main menu (not from the Memory organizer).

E.6 Custom Inspections programming

Arbitrary set of tasks dedicated to specific user defined Inspections can be programmed with application of Custom Inspection Editor Tool, accessible from Auto Sequence® Editor workspace. Custom Inspections are stored in dedicated file *.indf with user defined name. For application of Custom Inspections as a single test within Auto Sequence® group, appropriate file containing specific Custom Inspection should be opened first.

E.6.1 Creating and editing Custom Inspections



Custom Inspection Editor workspace is entered by selecting  icon from Auto Sequences® main menu. It is divided in two main areas, as presented on **Figure E.8**:

- 1 Custom Inspection **Name** and **Scope** of inspection (Visual or Functional)
- 2 **Name** of Custom Inspection Item tasks and **Type** of Item Pass / Fail checkbox marking

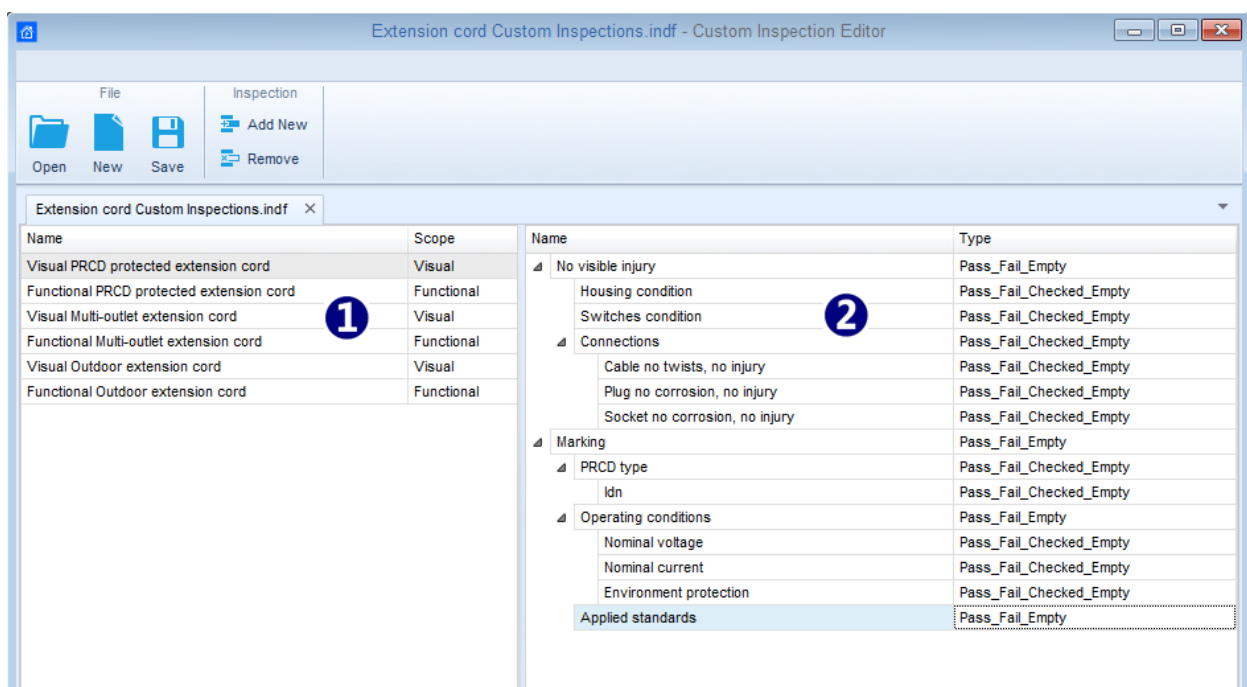


Figure E.8: Custom Inspection Editor workspace

Custom Inspection Editor Main menu options:



Opens existing Custom Inspection Data file.
By selecting, menu for browsing to location of *.indf file containing one or more Custom Inspections data appear on the screen. Selected file is opened in dedicated tab marked with file name.



Creates a new Custom Inspection Data file.
New tab with empty workspace is opened. Default name of the new tab is *Inspection Data File*; it could be renamed during Save procedure.



Saves / Saves as Custom Inspection Data file opened on active tab.
Menu for browsing to the folder location and editing of file name is opened. Browse to the location, confirm overwriting, if file already exists or edit file name to save it as a new Custom Inspection Data file.

Add New Custom Inspection.



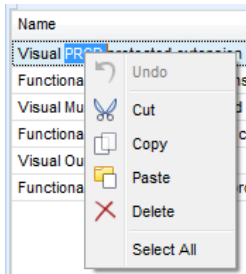
New inspection with default name *Custom Inspection* and default scope *Visual* appear on the editor workspace. It contains one Item task with default name *Custom Inspection* and default Type *Pass_Fail_Checked_Empty*. Default Name and Type can be edited – changed.

Remove selected custom inspection.



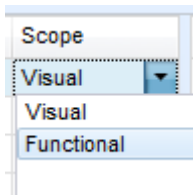
To select inspection, click to the inspection Name field. To remove it, select icon from editor main menu. Before removal, user is asked to confirm deletion.

Edit Name and Scope of Inspection



Inspection Name edit:

Click to the Inspection Name field to start editing it. Drag cursor, with left mouse button pressed, to select letters and words. Position cursor and double-click to select word of the name. Actions could be performed with keyboard also. Press right mouse button to activate Edit menu and select appropriate action as presented on the left figure. Menu is case sensitive; options currently not available are greyed out.

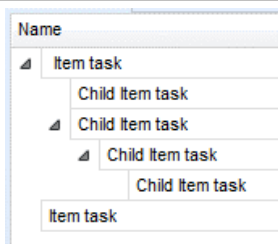


Inspection Scope edit:

Click to Inspection Scope field to open selection menu presented on left figure. Options:

- Visual** is intended for observation of test object
- Functional** allows functional test of observed object

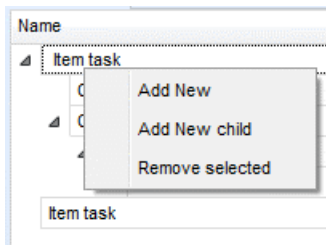
Edit Item task structure of Inspection



Item tasks of the selected Inspection are listed in Name column on the right side of Editor workspace.

Each Item task can have Child Item tasks, Child Item can have its own Child Item tasks and so on.

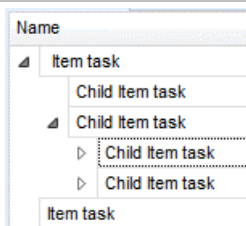
Arbitrary tree structure of Item tasks and subtasks can be built as presented on left figure.



ADD New Item task procedure:

Position cursor above Item task Name and apply right mouse click to select Item task and open menu with options:

- Add New:** new Item task is added on the top tree level
 - Add New Child:** new child Item task is added under selected Item
 - Remove selected:** delete selected Item task with all subtasks
- Default Name of New Item task is *Custom Inspection*, default Type *Pass_Fail_Checked_Empty* and both can be edited – changed.

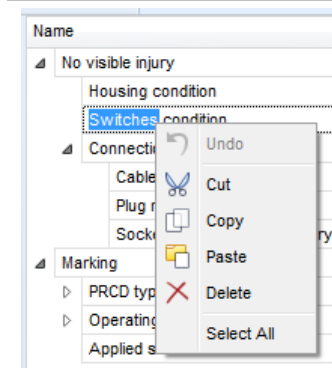


Item tasks containing Child Item tasks are marked with triangle in front of their Name.

Click on triangle mark:

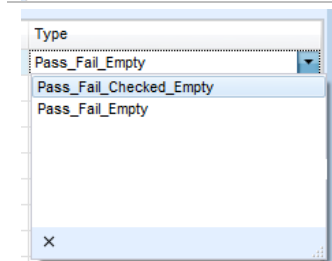
- collapse Item task tree structure
- expands Item task tree structure

Edit Name and Type of Item task



Edit Name of Item task:

Click to the Item task Name field to start editing it. Drag cursor, with left mouse button pressed, to select letters and words. Position cursor and double-click to select word of the name. Actions could be performed with keyboard also. Press right mouse button to activate Edit menu and select appropriate action as presented on the left figure. Menu is case sensitive; options currently not available are greyed out.



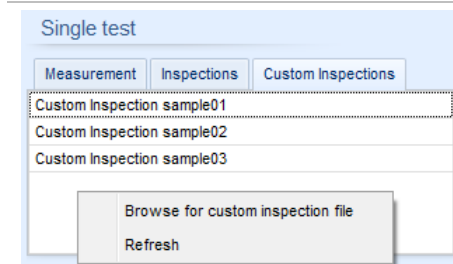
Edit Type of Item task:

Click to Item Type field to open selection menu presented on left figure. Selectable checkbox status assignment options are:
Pass_Fail_Checked_Empty: Pass, Fail, Checked, Empty (default)
Pass_Fail_Empty: Pass, Fail selection, Empty (default) value

E.6.2 Applying Custom Inspections

Custom inspections can be applied in Auto Sequences®. Direct assignment of Custom inspection to the Metrel ES manager structure objects is not possible. After custom created Inspection Data file is opened, available inspections are listed in Custom Inspections tab of Single test area of Auto Sequence® Editor, see chapter *E.1 Auto Sequence® Editor workspace* for details. Custom Inspection is added to Auto sequence as a Single test, see chapter *E.4 Creating / modifying an Auto Sequence®* for details.

Opening / changing Inspection Data File

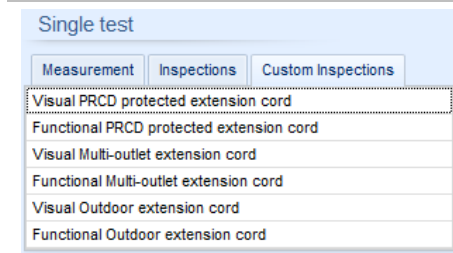


Position cursor within Custom inspections List area and apply mouse right click to open Option menu:

Refresh: Refresh content of already opened Inspection Data file.

Browse for custom Inspection file:

Menu for browsing to folder location of new Inspection Data file is opened.



After confirmation of selection, new Inspection Data file is opened and list of available Custom Inspections is changed.

Note:

- If Metrel ES Manager Work scope is changed, opened Inspection Data file remains active and available Custom Inspections remains the same.