

1. SAFETY WARNINGS

This instrument has been designed and tested according to IEC Publication 61010: Safety Requirements for Electronic Measuring Apparatus. This instruction manual contains warnings and safety rules which must be observed by the user to ensure safe operation of the instrument and to retain it in safe condition. Therefore, read through these operating instructions before starting using the instrument.

WARNING

- Read through and understand instructions contained in this manual before starting using the instrument.
- Save and keep the manual handy to enable quick reference whenever necessary.
- Be sure to use the instrument only in its intended applications and to follow measurement procedures described in the manual.
- Be sure to understand and follow all safety instructions contained in the manual.

Not following the above instructions may cause injury, instrument damage and/or damage to equipment under test.

The symbol  $\Delta$  indicated on the instrument means that the user must refer to related parts of the manual for safe operation of the instrument. Be sure to carefully read the instructions following each  $\Delta$  symbol in this manual.

- $\Delta$  **DANGER** is reserved for conditions and actions that are likely to cause serious or fatal injury.
- $\Delta$  **WARNING** is reserved for conditions and actions that can cause serious or fatal injury.
- $\Delta$  **CAUTION** is reserved for conditions and actions that can cause minor injury or instrument damage.

Following symbols are used on the instrument and in the instruction manual. Attention should be paid to each symbol to ensure your safety.

- Refer to the instructions in the manual.
- $\Delta$  This symbol is marked where the user must refer to the instruction manual so as not to cause personal injury or instrument damage.
- $\square$  Indicates an instrument with double or reinforced insulation.
- $\square$  Indicates that this instrument can clamp on bare conductors when measuring a voltage corresponding to the applicable Measurement category, which is marked next to this symbol.
- $\sim$  Indicates AC (Alternating Current).

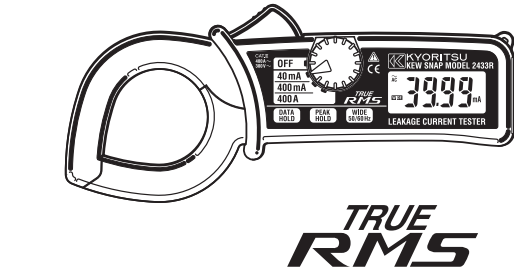

LEAKAGE CURRENT TESTER

KEW SNAP Series

KEW SNAP 2433R

KYORITSU ELECTRICAL INSTRUMENTS WORKS, LTD., TOKYO, JAPAN

DISTRIBUTOR

Kyoritsu reserves the rights to change specifications or designs described in this manual without notice and without obligations.

KYORITSU ELECTRICAL INSTRUMENTS WORKS, LTD.

2-5-20, Nakane, Meguro-ku, Tokyo, 152-0031 Japan  
Phone: +81-3-3723-0131  
Fax: +81-3-3723-0152  
Factory: Ehime, Japan

www.kew-ltd.co.jp

- (1) Set the Range Selector Switch to the desired position. Current to measure should be within the selected measuring range.
- (2) Normal measurement (See Fig.1,2):  
Press the jaw trigger to open the transformer jaws and close them over one conductor only. Measured current value is shown on the display. Earth leakage current or small current that flows through a grounded wire can also be measured by this method.
- (3) Measuring out of balance leakage current (See Fig. 3):  
Clamp onto all conductors except a grounded wire. Measured current value is shown on the display.

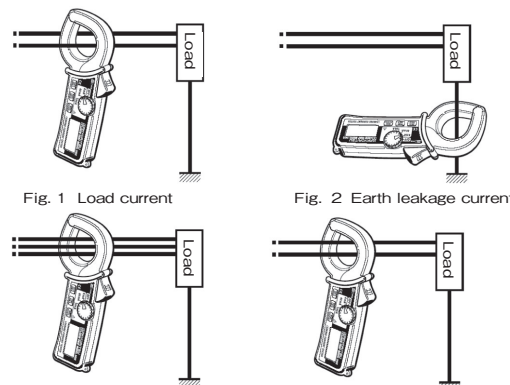

Fig. 3 Measuring out of balance leakage current

6-2 How to Use Frequency Selector Button

When high frequencies from such equipment as inverters are present in the circuit under test, the instrument measures AC current of not only 50Hz or 60Hz of fundamental frequency but also of these high frequencies and harmonics.

To eliminate the effect of such high frequency noise and measure AC current of 50Hz or 60Hz fundamental frequency, a "high-cut" filter circuit is incorporated into the instrument which works when "50/60Hz" frequency response is selected with the Frequency Selector Button. Cut-off frequency of the "high-cut" filter is about 160Hz with attenuation characteristic of approx. -24dB/octave.

When the Frequency Selector Button is pressed, "50/60Hz" mark is shown on the left side of the display. When the Frequency Selector Button is pressed again, frequency response is switched to WIDE with "WIDE" mark shown on the display. Output characteristic are shown in Fig.4.

DANGER

- Never make measurement on a circuit having potential of 300VAC or greater.
- Do not attempt to make measurement in the presence of flammable gasses. Otherwise, the use of the instrument may cause sparking, which leads to an explosion.
- The transformer jaws are made of metal and their tips are not completely insulated. Be especially careful about the possible shorting where the equipment under test has exposed metal parts.
- Never attempt to use the instrument if its surface or your hand is wet.
- Do not exceed the maximum allowable input of any measurement range.
- Never open the battery compartment cover when making measurement.
- Never try to make measurement if any abnormal conditions, such as broken Transformer jaws or case is noted.
- The instrument is to be used only in its intended applications or conditions. Otherwise, safety functions equipped with the instrument doesn't work, and instrument damage or serious personal injury may be caused.

WARNING

- Never attempt to make any measurement, if any abnormal conditions are noted, such as broken case, cracked test leads and exposed metal parts.
- Do not install substitute parts or make any modification to the instrument. Return the instrument to Kyoritsu or your distributor for repair or re-calibration.
- Do not try to replace the batteries if the surface of the instrument is wet.
- Always switch off the instrument before opening the battery compartment cover for battery replacement.

CAUTION

- Make sure that the range selector switch is set to an appropriate position before making measurement.
- Do not expose the instrument to the direct sun, extreme temperatures or dew fall.
- Be sure to set the range selector switch to the "OFF" position after use. When the instrument will not be in use for a long period of time, place it in storage after removing the batteries.
- Use a damp cloth and detergent for cleaning the instrument. Do not use abrasives or solvents.

- Measurement Category:  
To ensure safe operation of measuring instruments, IEC 61010 establishes safety standards for various electrical environments, categorized as O to CAT IV, and called measurement categories. Higher-numbered categories correspond to electrical environments with greater momentary energy, so a measuring instrument designed for CAT III environments can endure greater momentary energy than one designed for CAT II.
- O : Circuits which are not directly connected to the mains power supply.
- CAT II : Electrical circuits of equipment connected to an AC electrical outlet by a power cord.
- CAT III : Primary electrical circuits of the equipment connected directly to the distribution panel, and feeders from the distribution panel to outlets.
- CAT IV : The circuit from the service drop to the service entrance, and to the power meter and primary over-current protection device (distribution panel).

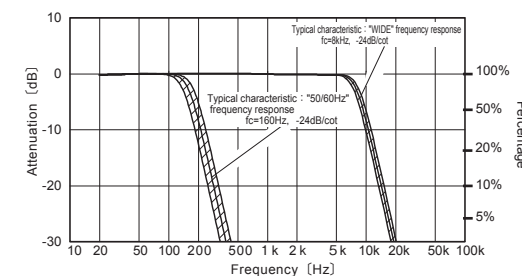
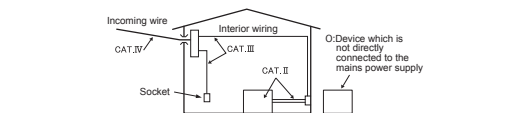

Fig.4 KEW SNAP 2433R Frequency Characteristic

Note: Characteristic of -24dB/octave means that signal magnitude declines to about one sixteenth of that at the initial frequency when frequency doubles. KEW SNAP 2433R have the following two settings for the Frequency Selector Button.

- WIDE (20Hz - approx. 8kHz): Permits measurement of currents of fundamental frequencies as well as currents of high frequencies generated by such equipment as inverters
- 50/60Hz (20-approx.160Hz) : Filters out high frequency currents and measures current of fundamental frequency only

Recently there has been increased use of power through inverters, switching regulators, etc. When the high frequency noise from such appliances leaks or flows into the ground through capacitors not filtering completely, the earth leakage breaker may trip even though there is no "actual" leakage. In such a case, the instrument do not give leakage current reading if "50/60Hz" frequency response is selected.

Take current readings with the 50/60Hz and WIDE frequency responses respectively to make effective use of the Frequency Selector Button.

6-3 Peak Current Measurement

- (1) Set the Range Selector Switch to the desired position.(Current to measure should not exceed the selected measuring range.)
- (2) Select "WIDE" or "50/60Hz" with the Frequency Selector Button.
- (3) With the transformer jaws clamped onto the conductor under test, press the Peak Hold Button to set the instrument to the peak measurement mode. ("P" is shown on the display.)

2. FEATURES

- Digital clamp tester for AC leakage measurement.
- Accurate true-RMS reading of AC current with distorted waveform.
- Least affected by external magnetic field, providing wide measuring range from very small to large currents.
- Designed to safety standard IEC 61010-2-032: Measurement category CAT, III, 300V and pollution degree 2.
- Tear drop shaped jaws for ease of use in crowded cable areas and other tight places.
- Data hold function to allow for easy readings in dimly lit or hard-to-reach locations.
- Provides filtering function to remove high frequency generated by such equipment as inverters.
- Peak hold function to allow for measurement of current variation as short as 10msec.
- Auto-power-off function prevents unnecessary power consumption
- Dynamic range of 4200 counts full scale.
- Large easy-to-read LCD display with letter height of 13mm.
- Operation confirming beeps.
- Insulation barrier at the tip of transformer jaws for improved safety.

3. SPECIFICATIONS

Measuring ranges and accuracy (Sine wave)

Range	Resolution	Measuring Range	Accuracy (Frequency range)
40mA	0.01mA	0~40.00mA	0~100A ±1.0%rdg±5dgt (50/60Hz) ±2.5%rdg±10dgt (20Hz~1kHz)
400mA	0.1mA	0~400.0mA	100~300A ±1.0%rdg±5dgt (50/60Hz) ±2.5%rdg±10dgt (40Hz~1kHz)
400A	0.1A	0~400.0A	300~400A ±2.0%rdg (50/60Hz) ±5.0%rdg (40Hz~1kHz)

- CF(Crest factor) ≤3(45~65Hz, less than 600A Peak)
  - ※100~400A : sine wave+2%rdg
  - Counts equal to or less than 3 counts are corrected to zero
  - Accuracy range of Frequency range of 50/60Hz mode is 50/60Hz.
  - The max indication at the 40mA/400mA range is 6000 counts.
  - Minute current may exist while zero is displayed at 400A/400mA range. Measurement should be made also at a lower range.

- Conversion method : Rms value detection
- Operating System : Sequential comparison
- Display : LCD with max. reading of 4200 (400A range), 6000 (40/400mA range)
- Low battery warning: "BATT" mark appears on the display
- Overrange Indication: "OL" appears on the display when upper limit of measuring range is exceeded
- Response Time: Approx. 2 seconds
- Sample Rate: Approx. 2.5 times per second
- Accuracy-Insured: 23°C±5°C, relative humidity 85% or less (without condensation)
- Temperature and Humidity Ranges: 0-40°C, relative humidity 85% or less (without condensation)
- Storage Temperature and Humidity Ranges: -20-60°C, relative humidity 85% or less (without condensation)
- Operable altitude: 2000m or less above sea level (indoor use)
- Power Source: Two 1.5V R03 (AAA) batteries
- Current Consumption: Approx. 21mA
- Measurement Time: Approx. 24 hours
- Auto-power-off Function: Turns power off about 10 minutes after the last switch operation

- (4) The display reads 1/√2 of the peak current value. Therefore, an rms reading is shown when current of a sinusoidal waveform is measured.
  - (5) After peak measurement, press the Peak Hold Button to return to the normal measurement mode.
- Note: When leakage current is measured in the peak measurement mode, the reading may change if the transformer jaws are opened and closed. Please read the display with the conductor under test clamped, otherwise, after fixing the display by using the data hold function, please remove the instrument from the conductor to be measured, and read the display. To measure the peak current again, please release the data hold, and return the instrument to the normal measurement mode once with the Peak Hold Button, then set it in the peak measurement mode. Counts equal to or less than 5 counts are corrected to zero.

7. OTHER FUNCTIONS

7-1 Auto-Power-Off Function

This is a function to prevent the instrument from being left powered on and conserve battery power. The instrument automatically turns off about 10 minutes after the last switch or button operation. To return to the normal mode, turn the Range Selector Switch to OFF, then to the desired position.  
Disabling Auto-Power-Off Function:  
To disable the auto-power-off function, power on the instrument with the Data Hold Button pressed. About 3 seconds after powering on the instrument, "P.OFF" is shown on the display. To enable the auto-power-off function, turn on the instrument without pressing the Data Hold Button.  
Note: The auto-power-off function is disabled in the peak measurement mode.

7-2 Date Hold Function

This is a function to freeze the readings on the display. When the Data Hold Button is pressed once, the current reading is held even though current under test varies. "H" mark is shown on the upper right corner of the display.  
To exit the data hold mode, press the Data Hold Button again.  
Note: When the auto-power-off function works while the instrument is in the data hold mode, data hold is cancelled.

- Safety Standard: IEC 61010-1, IEC 61010-2-032 (Measurement CAT, III 300V, pollution degree 2)  
EMC : EN61326, EN55022, EN61000-4-2(performance criterion B), EN61000-4-3(performance criterion A)  
Environmental standard: EN50581  
480AAC max. for 10 seconds  
3470VACrms (50/60Hz) for 5 sec. between metal part of transformer jaws and housing case (except transformer jaw case)
- Overload Protection: 50MΩ or greater at 1000V between metal part of transformer jaws and housing case (except transformer jaw case)
- Withstand Voltage: Approx. 40mm in diameter max. 185(L) × 81(W) × 32(D)mm
- Conductor Size: Approx. 270g including batteries
- Weight: Two R03 (AAA) batteries
- Accessories: Carrying case Model 9052, Instruction manual
- Optional Accessories: Multi-Tran Model 8008

Reference "Effective Value (RMS)"  
Most alternating currents and voltages are expressed in effective values, which are also referred to as RMS (Root-Mean-Square) values.  
The effective value is the square root of the average of square of alternating current or voltage values. Many clamp meters using a conventional rectifying circuit have "RMS" scales for AC measurement. The scales are, however, actually calibrated in terms of the effective value of a sine wave though the clamp meter is responding to the average value. The calibration is done with a conversion factor of 1.111 for sine wave, which is found by dividing the effective value by the average value. These instruments are therefore in error if the input voltage or current has some other shape than sine wave.  
\*CF (Crest Factor) is found by dividing the peak value by the effective value.  
Examples:  
Sine wave: CF=1.414 Square wave with a 1: 9 duty ratio: CF=3

4. INSTRUMENT LAYOUT

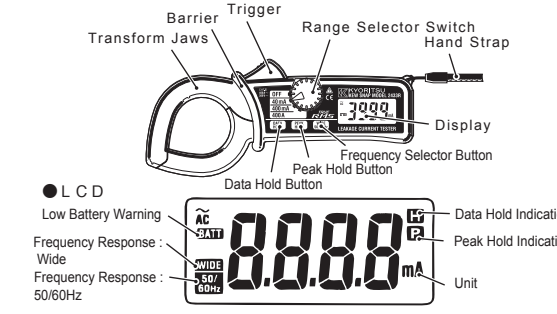

- LCD
- Low Battery Warning
- Frequency Response : Wide
- Frequency Response : 50/60Hz
- Data Hold Indication
- Peak Hold Indication
- Unit

8. BATTERY REPLACEMENT

- $\Delta$  **WARNING**  
In order to avoid possible shock hazard, always set the Range Selector Switch to the OFF position before trying to replace the batteries.
- $\Delta$  **CAUTION**  
● Do not mix new and old batteries.  
● Install batteries in the orientation as shown inside the battery compartment, observing correct polarity.

When the battery voltage warning mark "BATT" is shown on the top left corner of the LCD, replace the batteries. Note that the display blanks and "BATT" mark is not shown if the batteries are completely exhausted.  
(1) Set the Range Selector Switch to "OFF."  
(2) Loosen the battery-compartment-cover-fixing screw on the lower back of the instrument.  
(3) Replace the batteries with two new R03 (AAA) 1.5V batteries.  
(4) Put the battery compartment cover back in place and tighten the screw.  
Note: For use for a long period of time, use alkaline batteries (LR03).

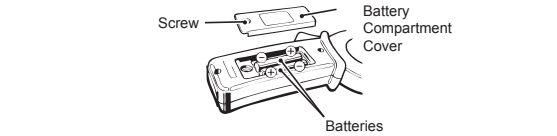

5. PREPARATIONS FOR MEASUREMENT

- 5-1 Checking Battery Voltage  
Set the Range Selector Switch to any position other than the OFF position. If the marks on the display is clearly visible without "BATT" mark showing, battery voltage is OK. If the display blanks or "BATT" is indicated, replace the batteries according to section 8: Battery Replacement.
- NOTE**  
When the instrument is left powered on, the auto-power-off function automatically shut the power off. The display blanks even if the Range Selector Switch is set to a position other than the OFF position in this state. To power on the instrument, turn the Range Selector Switch or press the Data Hold Button. If the display still blanks, the batteries are completely exhausted. Replace the batteries.

- 5-2 Checking Switch Setting  
Make sure that the Range Selector Switch is set to the appropriate range.  
Also make sure that data hold function is not enabled. If inappropriate range is selected, desired measurement cannot be made.

6. OPERATING INSTRUCTIONS

- 6-1 Current Measurement  
 $\Delta$  **DANGER**  
● In order to avoid possible shock hazard, never make measurement on circuits having a potential of 300VAC or greater.  
● The transformer jaws are made of metal and their tips are not completely insulated. Be especially careful about the possible shorting where the equipment under test has exposed metal parts.  
● Never make measurement with the battery compartment cover removed.  
● When measuring current is 300A or more (400Hz or more), be sure to stop measurement within 5 minutes. Otherwise, transformer jaws may heat to cause a fire or deformation of molded parts, which will degrade insulation.  
● Keep your fingers and hands behind the barrier during measurement.

- $\Delta$  **CAUTION**  
● Take sufficient care to not to apply shock, vibration or excessive force to the jaw tips. Otherwise, precisely adjusted Transformer Jaw tips will be damaged.  
● When a foreign substance is stuck in the jaw tips or they cannot properly engage, the transformer jaws do not fully close. In such a case, do not release the jaw trigger abruptly or attempt to close the transformer jaws by applying external force. Make sure that the jaws close by themselves after removing the foreign substance or making them free to move.  
● The maximum size of a conductor to be tested is 40mm in diameter. Accurate measurement cannot be made on a conductor larger than this, because the transformer jaws cannot fully close.  
● When measuring large current, the transformer jaws may buzz. This has no effect on the instrument's performance or safety.  
● Sensitive transformer jaws are used for Leakage clamp meter. Because of the characteristics of transformer jaws, which can be opened and closed, it is impossible to eliminate the interference of external magnetic field completely. If there are something, which generating large magnetic field at a nearby site, current value can be displayed ( "0" cannot be displayed.) before clamping on the conductor. For such a case, please use the instrument at a location far from the thing, which generating magnetic field.  
Following are the typical things generating magnetic field.  
· Conductor fed large current  
· Motor  
· Equipment which has magnet  
· Integrating wattmeter

9. OPTIONAL ACCESSORIES

- Model 8008 (Multi-Tran)  
These models help KEW SNAP 2433R to measure current greater than 3000A or to make measurement on a large bus-bar or conductor.  
(1) Set the Range Selector Switch to "400A."  
(2) As shown, open the jaws and close them over the pickup coil of Model 8008.  
(3) Clamp on a conductor with Model 8004 or Model 8008.  
(4) Take the reading and multiply it by 10.

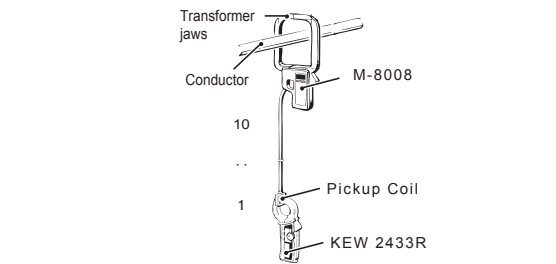

	Max. Conductor Size	Measuring Range	Current Transformation Ratio
M-8008	100mm in diameter	0~3000A	10:1

Note: Model 8008 cannot be used for leakage current measurement. For detailed specifications, refer to the instruction manual for Model 8008.